



Patrick Lucas
R-STUD LLC
3200 Park Center Dr
14th floor
Costa Mesa, CA 92626
(updated address)

Date: 2018/06/01
Subscriber: None
PartySite: 1824915
File No: R39364
Project No: 4788356132
PD No: 18024648
Type: R
PO Number: 1009

Subject: **Initial Production Inspection**

PLEASE NOTE: YOU ARE NOT AUTHORIZED TO SHIP ANY PRODUCTS BEARING ANY UL MARKS UNTIL THE INITIAL PRODUCTION INSPECTION HAS BEEN SUCCESSFULLY CONDUCTED BY THE UL FIELD REPRESENTATIVE.

An Initial Production Inspection (IPI) is an inspection that must be conducted prior to the first shipment of products bearing the UL Mark. This is to ensure that products being manufactured are in accordance with UL's requirements including the Follow-Up Service Procedure. After the UL Representative has verified compliance of your product(s), authorization will be granted for shipment of product(s) bearing the appropriate UL Marks as denoted in the Procedure.

Inspections at your plant will be conducted under the supervision of DANIEL DEATHERAGE, UL INSPECTION CENTER NORTHWEST AREA OFFICE, UL LLC, FIELD SERVICES DEPT, NORTH REGION, 2600 NW LAKE RD, CAMAS, WA, United States, 98607., PHONE: 360.597.8635, EMAIL: Dan.Deatherage@ul.com

Marks as needed may be obtained from UL LABEL CENTER USA, UL LLC, 333 PFINGSTEN RD, NORTHBROOK, IL, United States, 60062. PHONE: 847-664-3030, TOLL FREE: 877-854-3577 EXT 43030, FAX: 847-509-6201, EMAIL: LABELCENTER.USA@UL.COM.

Please file revised pages and illustrations in place of material of like identity. New material should be filed in its proper numerical order.

NOTE: Follow-Up Service Procedure revisions DO NOT include Cover Pages, Test Records and Conclusion Pages. Report revisions DO NOT include Authorization Pages, Indices, Section General Pages and Appendixes.

Please review this material and report any inaccuracies to UL's Customer Service Professionals. Contact information for all of UL's global offices can be found at <http://ul.com/aboutul/locations>.

If you'd like to receive updated materials FASTER, UL offers electronic access and/or delivery of this material. For more details, contact UL's Customer Service Professionals as shown above., referring to the above Project and/or PD Numbers.

This material is provided on behalf of UL LLC (UL) or any authorized licensee of UL.

NBK File

UL INSPECTION CENTER 969

Production Date: UNKNOWN
Contact: MR/MS Patrick
Phone: Lucas
EMail: 310-383-8699
patrick@rstud.com

ADDENDUM TO TRANSMITTAL LETTER

Patrick Lucas
R-STUD LLC
3200 Park Center Dr
14th Floor
Costa Mesa, CA 92626

Date: 2018/06/01
Subscriber: None
PartySite: 1824915
File No: R39364
Project No: 4788356132
PD No: 18024648
Type: R
PO Number: 1009

Subject: **Initial Production Inspection**

The following material resulting from the investigation under the above numbers is enclosed.

Issue

<u>Date</u>	<u>Vol</u>	<u>Sec</u>	<u>Pages</u>	<u>Revised Date</u>
2018/05/30	1	1	Cert of Compliance	
2018/05/30	1	1	Add New Volume	
2018/05/30			Add New Indep Report	

"If there are illegible images in this package, legible images may be found online via MyHome@UL under My UL Reports/CDA."

Follow-Up Service Procedure

DO NOT DISCARD THIS PAGE

It is important to keep UL Procedures and Test Reports up-to-date as new or revised pages are received. Correct maintenance will decrease the amount of time the UL Representative spends when visiting your facility.

UL LLC offers MyHome @UL, a dedicated website providing secure access to online tools and databases that can help simplify your compliance activities. You can customize your personal MyHome @UL page to include the content needed most, including timely information about certification updates and links to other Web sites you visit regularly. Visit <http://my.home.ul.com/> to sign up today!

PAGES (in content order)	FUNCTION	HOW TO UPDATE
Authorization Page	Displays the Product Category, the type of Follow-Up Service (Type R=Reexamination / Type L=Label), the File Number and the Volume Number associated with each Applicant's, Manufacturer's and Listee's company name and address.	Replace existing page by matching the UL File Number and Volume Number. Discard the older page (refer to "Issued" or "Revised" date).
Addendum to Authorization Page*	Lists the additional names and addresses of manufacturing locations, when multiple locations exist	Replace existing page by matching the UL File Number and Volume Number. Discard the older page (refer to "Issued" or "Revised" date).
Listing Mark Data (LMD), Classification Mark Data (CMD) or Recognized Component Mark Data (RCMD) Pages* #	Used only for products covered under Type R Service. Displays the correct LMD, CMD, or RCMD Mark, the Control Number for Listed and Classified categories and additional information regarding minimum size, application, procurement, and any other optional markings, in addition to the UL Mark.	Replace existing page by matching the UL File Number and Volume Number. Discard the older page (refer to "Issued" or "Revised" date).
Multiple Listing (ML) Correlation Sheet	Correlates product model numbers between those products made by a Manufacturer for the Basic Applicant and those supplied to another company, the Multiple Listee.	Replace, add or delete page(s) with most current "Issued" or "Revised" date.
Index*	Catalogs the contents of the Procedure by some logical means, i.e. Section Number, Report Reference Number, or Issue Date.	Replace present page by matching the UL File Number, Volume Number, Page Number and most current "Revised" date.
Appendices* # (App.)	Contains instructions for the Manufacturer and UL Representative concerning specific responsibilities and required periodic tests. May also outline tests to be conducted on samples to be forwarded to UL's facilities.	Replace present page by matching the UL File Number, Volume Number, Appendix letter (eg. App. A), Page Number and most current "Revised" date.
	Standardized Appendix Pages are the same for all manufacturers within a particular product category.	Replace present page by matching the Appendix letter (eg. App. A), Page Number and most current "Revised" date.
Follow-Up Inspection Instructions (FUII) Pages*	Contains information similar to that in the Appendices. FUII Pages are issued as part of the Procedure when a UL Standard is used in conjunction with the Procedure, and are the same for all manufacturers within a particular category.	Replace present pages by matching the Page Number and most current "Issued" or "Revised" date.
Section General* # (Sec. Gen.)	Contains description, requirements, identifications and/or specifications that are common to all products covered by the entire volume and supplements the information provided in the Description Section.	Replace present page by matching the UL File Number, Volume Number, Page Number and most current "Revised" date.
Description, or Section (Sec.)	Contains the specific description of one or more products or systems. This includes written text supplemented by photographs, drawings, etc., as necessary, to define features that affect compliance with the applicable requirements.	Replace present page by matching the UL File Number, Volume Number, Section Number, Page Number and most current "Issued" date.

* The above page(s) may not appear in all UL Follow-Up Service Procedures; UL's Conformity Assessment Services staff determines their inclusion.

These pages are combined in the **Generic Inspection Instructions** for International Style Reports, identified, as example by Vol. X1, X2, etc.

PLEASE NOTIFY YOUR LOCAL UL OFFICE OF ANY CHANGES IN CONTACT NAME, COMPANY NAME OR ADDRESS, SO THIS MATERIAL AND IMPORTANT INFORMATION CONTINUES TO BE DELIVERED TO YOUR FACILITY WITHOUT INTERRUPTION.



FOLLOW-UP SERVICE PROCEDURE
(TYPE R)

FRAMING MEMBERS
(CIKV)

Manufacturer: SEE ADDENDUM FOR MANUFACTURER LOCATIONS

Applicant: 1824915 (Party Site)
R-Stud LLC
3200 Park Center Dr
14th Floor
Costa Mesa, CA 92626 (updated)

Listee/Classified Co.: 1824915 (Party Site)
SAME AS APPLICANT

This Follow-Up Service Procedure authorizes the above Manufacturer(s) to use the marking specified by UL LLC, or any authorized licensee of UL LLC, including the UL Contracting Party, only on products when constructed, tested and found to be in compliance with the requirements of this Follow-Up Service Procedure and in accordance with the terms of the applicable service agreement with UL Contracting Party and any applicable Service Terms. The UL Contracting Party for Follow-Up Services is listed on addendum to this Follow-Up Service Procedure ("UL Contracting Party"). UL Contracting Party and UL LLC are referred to jointly herein as "UL."

UL further defines responsibilities, duties and requirements for both Manufacturers and UL representatives in the document titled, "UL Mark Surveillance Requirements" that can be located at the following web-site: <http://www.ul.com/fus> and in the document titled "UL and Subscriber Responsibilities" that can be located at the following website: <http://www.ul.com/responsibilities>. Manufacturers without Internet access may obtain the current version of these documents from their local UL customer service representative or UL field representative. For assistance, or to obtain a paper copy of these documents or the applicable Service Terms, please contact UL's Customer Service at <http://ul.com/aboutul/locations/>, select a location and enter your request, or call the number listed for that location.

The Applicant, the specified Manufacturer(s) and any Listee/Classified Co. in this Follow-Up Service Procedure must agree to receive Follow-Up Services from UL Contracting Party. If your applicable agreement is a Global Services Agreement ("GSA") with an effective date of January 1, 2012 or later and this Follow-Up Service Procedure is issued on or after that effective date, the Applicant, the specified Manufacturer(s) and any Listee/Classified Co. will be bound to a Service Agreement for Follow-Up Services upon the earliest by any Subscriber of use of the prescribed UL Mark, acceptance of the factory inspection, or payment of the Follow-Up Service fees which will incorporate such GSA, this Follow-Up Service Procedure and the Follow-Up Service Terms which can be accessed by clicking here: <http://www.ul.com/contracts/Terms-After-12-31-2011>. In all other events, Follow-Up Services will be governed by and incorporate the terms of your applicable service agreement and this Follow-Up Service Procedure.

It is the responsibility of the Listee/Classified Co. to make sure that only the products meeting the aforementioned requirements bear the authorized Marks of UL LLC, or any authorized licensee of UL LLC.

This Follow-Up Service Procedure contains information for the use of the above Manufacturer(s) and representatives of UL and is not to be used for any other purpose. It is provided to the Manufacturer with the understanding that it will be returned upon request and is not to be copied in whole or in part.

This Follow-Up Service Procedure, and any subsequent revisions, is the property of UL and is not transferable. This Follow-Up Service Procedure contains confidential information for use only by the above named Manufacturer(s) and representatives of UL and is not to be used for any other purpose. It is provided to the Subscribers with the understanding that it is not to be copied, either wholly or in part unless specifically allowed, and that it will be returned to UL, upon request.

Capitalized terms used but not defined herein have the meanings set forth in the GSA and the applicable Service Terms or any other applicable UL service agreement.

UL shall not incur any obligation or liability for any loss, expense or damages, including incidental, consequential or punitive damages arising out of or in connection with the use or reliance upon this Follow-Up Service Procedure to anyone other than the above Manufacturer(s) as provided in the agreement between UL LLC or an authorized licensee of UL LLC, including UL Contracting Party, and the Manufacturer(s).

UL LLC has signed below solely in its capacity as the accredited entity to indicate that this Follow-Up Service Procedure is in compliance with the accreditation requirements.

Bruce A. Mahrenholz
Director
North American Certification Program

LOCATION

1824915 (Party Site)
R-Stud LLC
3200 Park Center Dr
14th Floor
Costa Mesa, CA 92626

Factory ID: None
UL Contracting Party for above site is: UL LLC

Classification Mark Data Page

(FILE IMMEDIATELY AFTER AUTHORIZATION PAGE)

CLASSIFICATION MARK

COMPOSITION AND ELEMENT

The Classification Mark shall consist of the following and shall appear on the carton.

**FRAMING MEMBERS
FIRE RESISTANCE CLASSIFICATION
DESIGN NO(S) . _____
SEE UL FIRE RESISTANCE DIRECTORY
< R39364 >**

or

**FRAMING MEMBERS
FIRE RESISTANCE CLASSIFICATION
SEE UL FIRE RESISTANCE DIRECTORY
< R39364 >**

Where indicated in the individual Classifications, the Classification Mark may also include the statement:

**ALSO CLASSIFIED IN ACCORDANCE WITH
ASTM E90, "STANDARD TEST METHOD FOR LABORATORY
MEASUREMENT OF AIRBORNE SOUND TRANSMISSION LOSS OF
BUILDING PARTITIONS AND ELEMENTS"**

and/or

**ALSO CLASSIFIED IN ACCORDANCE WITH
ASTM E492, "STANDARD TEST METHOD FOR LABORATORY
MEASUREMENT OF IMPACT SOUND TRANSMISSION
THROUGH FLOOR-CEILING ASSEMBLIES
USING THE TAPPING MACHINE"**

MARKING

The following symbol shall be located adjacent to or in close proximity to the regular Classification Mark as shown above.



The minimum height of the registered trademark symbol ® shall be 3/64 of an inch. When the overall diameter of the UL Mark is less than 3/8 of an inch, the trademark symbol may be omitted if it is not legible. Camera-ready artwork and relative proportions are available online at www.ul.com.

PROCUREMENT

The manufacturer may reproduce the Mark or obtain it from an authorized label supplier. Authorized label suppliers can be found online at www.ul.com.

<u>Product Designation</u>	<u>Section</u>	<u>Independent Report Date</u>
Type R-Stud and R-Track	1	2018-05-30

APPENDIX A

FIELD REPRESENTATIVE:

During each factory visit, the Field Representative shall accomplish the following:

1. Check finished products for compliance with physical specifications as outlined in this procedure.
2. Check the manufacturer's records for minimum yield strength of steel. Records may consist of certification from supplier or in house tests.
3. Check manufacturer's records for calibration of micrometers used to measure steel thickness from an independent service company. The micrometers shall be calibrated a minimum of once per year.
4. Verify minimum thickness of steel.
5. Check for Classification Marking as specified.

SAMPLES FOR REGULAR INSPECTION:

The Field Representative shall select a minimum of two steel studs and steel tracks as the sample lot.

Procedure in Case of Failure - If one of the two selected samples fails to meet the specifications, four more samples shall be selected and examined. If one fails, the lot shall be rejected. In the event that a lot of material is rejected, the manufacturer may thoroughly review the lot and resubmit any portion of it for re-inspection of all the specifications.

Should the manufacturer elect to ship products which do not meet the specifications of this procedure, the label shall not be applied to the products or, if previously labeled, the labels shall be removed from the product.

RESERVED FOR FUTURE USE

RESERVED FOR FUTURE USE

APPENDIX D

RESPONSIBILITIES OF THE MANUFACTURER:

The manufacturer's include, but are not limited to:

1. Restricting the use of the Classification Markings that reference UL (either directly or by use of the name, an abbreviation of the name, the UL symbol or Recognized Component Mark, or indirectly by means of agreed upon markings that are understood to indicate acceptance by UL) to those products that are found by the manufacturer's own inspection to comply with the Follow-Up Service Procedure description. The use of such markings is further limited by the agreements that have been executed by the subscriber and UL.
2. Maintain production records, station charts and quality control test reports covering the product to which the UL mark was applied. The records, charts and reports shall contain sufficient information to determine compliance with the Follow-Up Service Procedure.
3. Maintaining records of tests conducted. The records shall include material manufacturer's name and type designation, tests performed, test results and the disposition of any nonconforming material.
4. Maintain records of verification of yield strength of the incoming steel (letters of certification from suppliers) or in house tests if letters of certification were not supplied.
5. Maintain records of annual calibration of micrometers used to measure steel thickness from an independent service company.

DESCRIPTION

PRODUCT COVERED:

USC, CNC The products covered in this section are channel-shaped steel studs designated "R-Stud" and channel-shaped steel track designated "R-Track" intended for use in wall assemblies.

MANUFACTURING PROCESS:

All steel coils are to be accompanied by a Mill Certificate.

Prior to product fabrication, coils are to be checked for gauge thickness, yield strength, and galvanized coating for the product that is to be manufactured.

The studs and track are formed through a computer automated process, which consists of roll forming, punching, embossing to form studs to the correct shape specified in ILL-1 supplementary to this procedure.

The product is visually checked during manufacturing with dimensional checks being performed on the finished product every 100 pieces produced to ensure that the material conforms for the web, flange, lip return, knock outs twist, camber, bow, flare and over bend are within specifications and adjustments are made as necessary.

The finished product is then packaged in bundles. The bundles are then strapped together to form larger bundles. Product is then stored in inventory until needed.

COMPONENTS:

The steel used to manufacture the load-bearing studs and track is to be ASTM A1003, Structural Grade 50, minimum 18 MSG (0.044 inch finished thickness with galvanization) and shall have a minimum G60 galvanized coating.

FINISHED PRODUCT:

The steel studs shall meet the minimum bare metal thickness, dimensions, yield strength and thickness of galvanized coating.

Figure 1 illustrates the cross-section of the R-Stud with key dimensional requirements detailed. Figure 2 illustrates the cross-section of the R-Track with key dimensional requirements detailed. The tolerances shall be as shown in attached ILL-1. Key dimensions detailed in this procedure supersede any dimensional conflicts with ILL-1 for UL classified products.

Figure 1. Cross section of Key Stud Dimensions

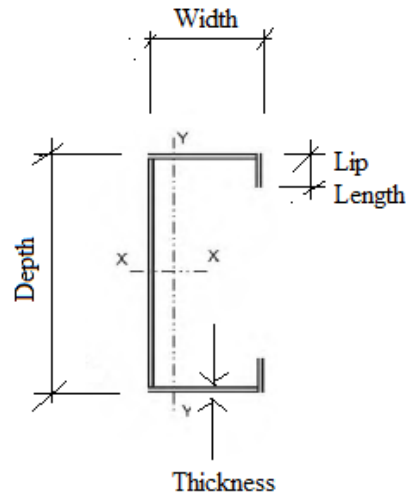

The dimensions of all R-Studs shall meet the requirements in Table 1.

Table 1. Dimension Requirements of R-Studs

Minimum Depth (inches)	Minimum Width (inches)	Minimum Lip Length (inches)	Minimum Metal Thickness (inches)	Minimum Mill Cert Yield strength (ksi)
3-5/8	1-5/8	7/8	0.044	50

Figure 2. Cross section of Key Track Dimensions

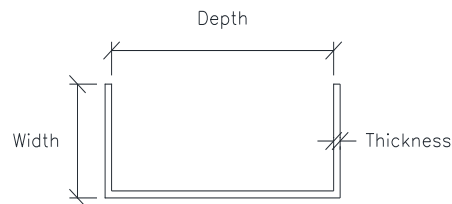

The dimensions of all R-Tracks shall be as per the following Table 2.

Table 2. Dimensional Requirements of R-Tracks

Minimum Depth (inches)	Minimum Width (inches)	Minimum Metal Thickness (inches)	Minimum Cert Yield Strength (ksi)
3-5/8	1-15/16	0.044	50

Openings formed in the web of the R-stud and R-Track shall be sized and spaced in accordance with the drawings in ILL-1. The openings shall be formed by punching out a "dog bone" pattern in the stud and folding back the remaining material. The fold backs shall have minimum depths in accordance with ILL-1.

CLASSIFICATION MARKING:

Each carton or bundle of R-Stud framing members or each individual R-Stud, or each bundle of R-Track framing members or each individual R-Track complying with the description and specifications of this Procedure shall be eligible to bear the Classification Marking of UL LLC as shown on the Classification Data Marking Page(s).

ADDITIONAL MARKING:

In addition to the Classification Marking, the following information shall be present:

1. Classified Company's name and/or R39364.
2. Stud designation - Note: The stud designation does not have to appear on the label if it is printed or embossed on each piece. The stud designation shall conform to the nomenclature as described in Figure 3.

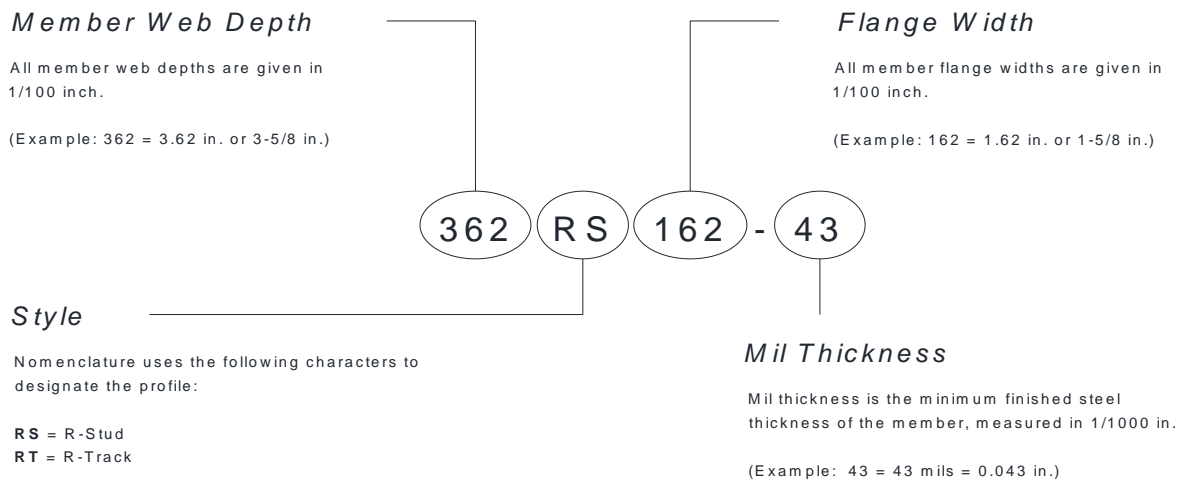
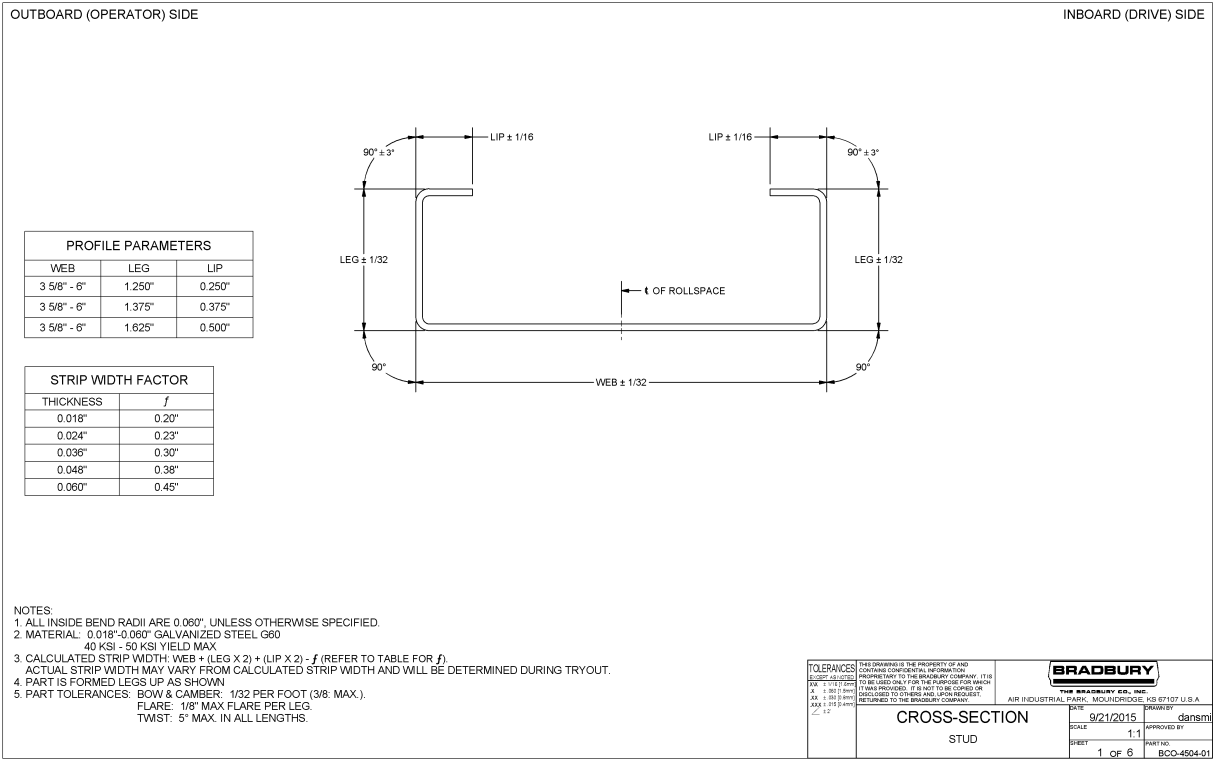
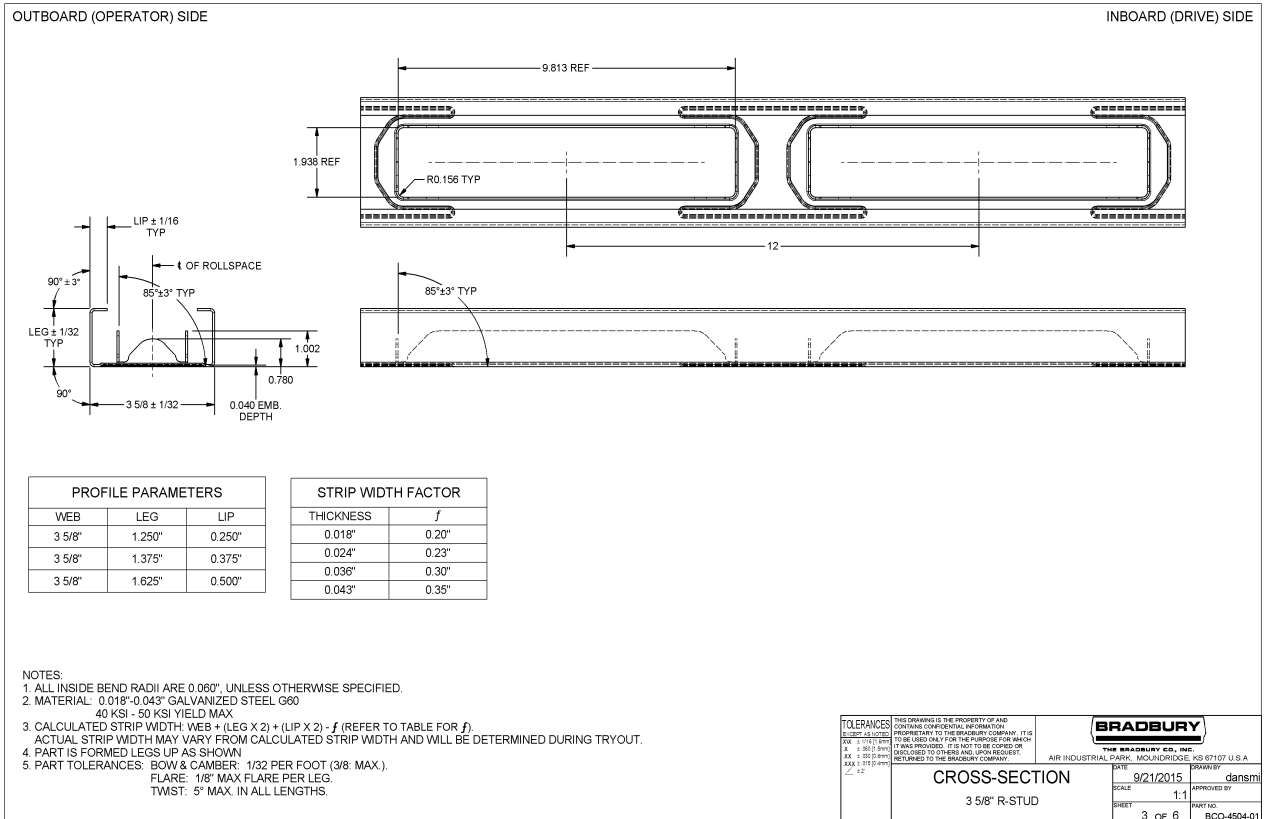
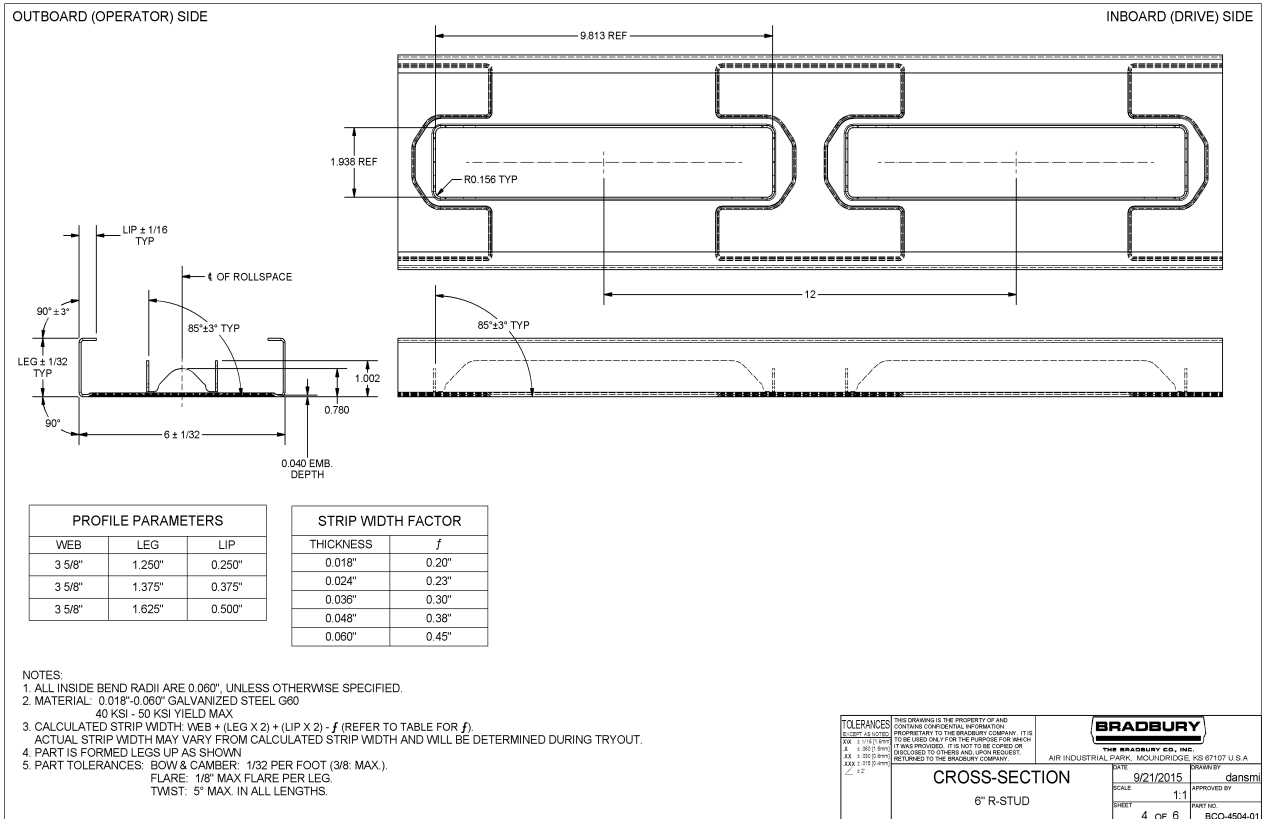
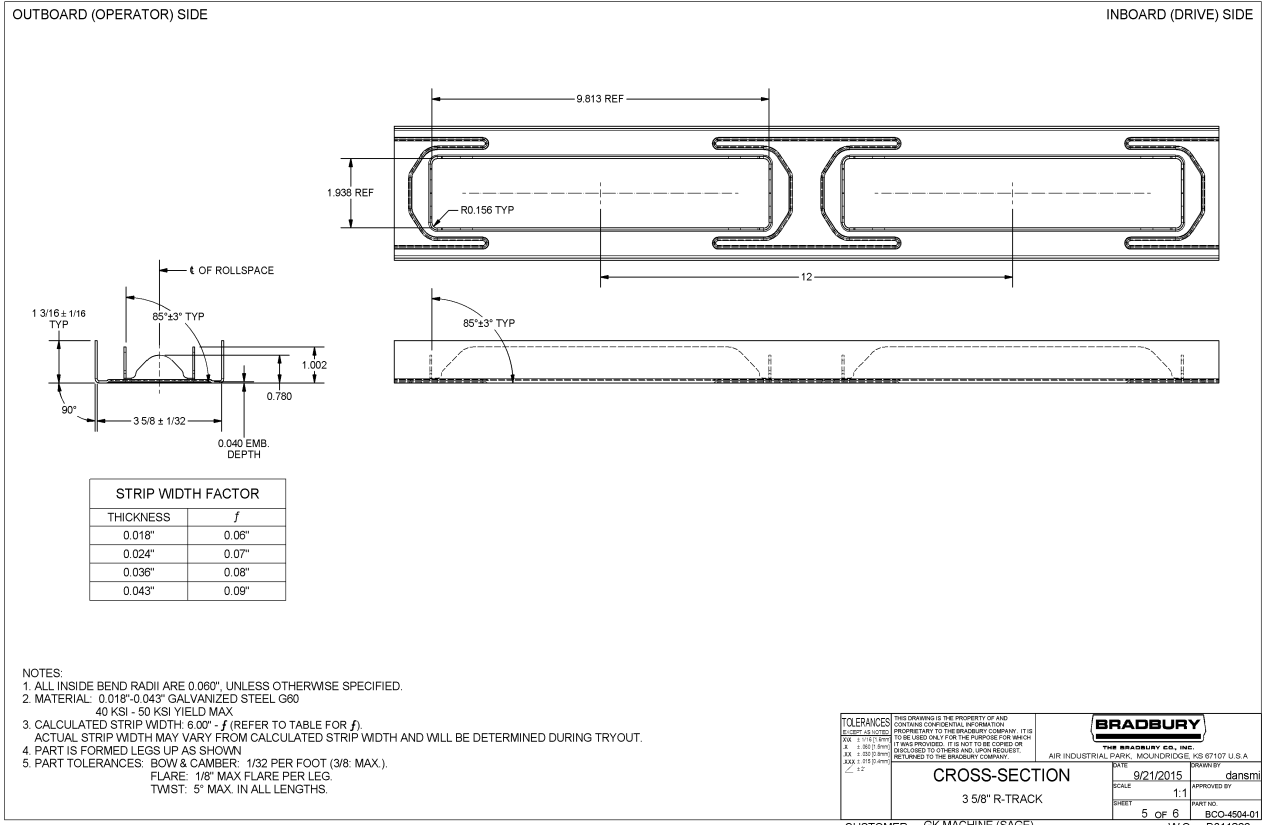

Figure 3. Stud and track designation nomenclature.









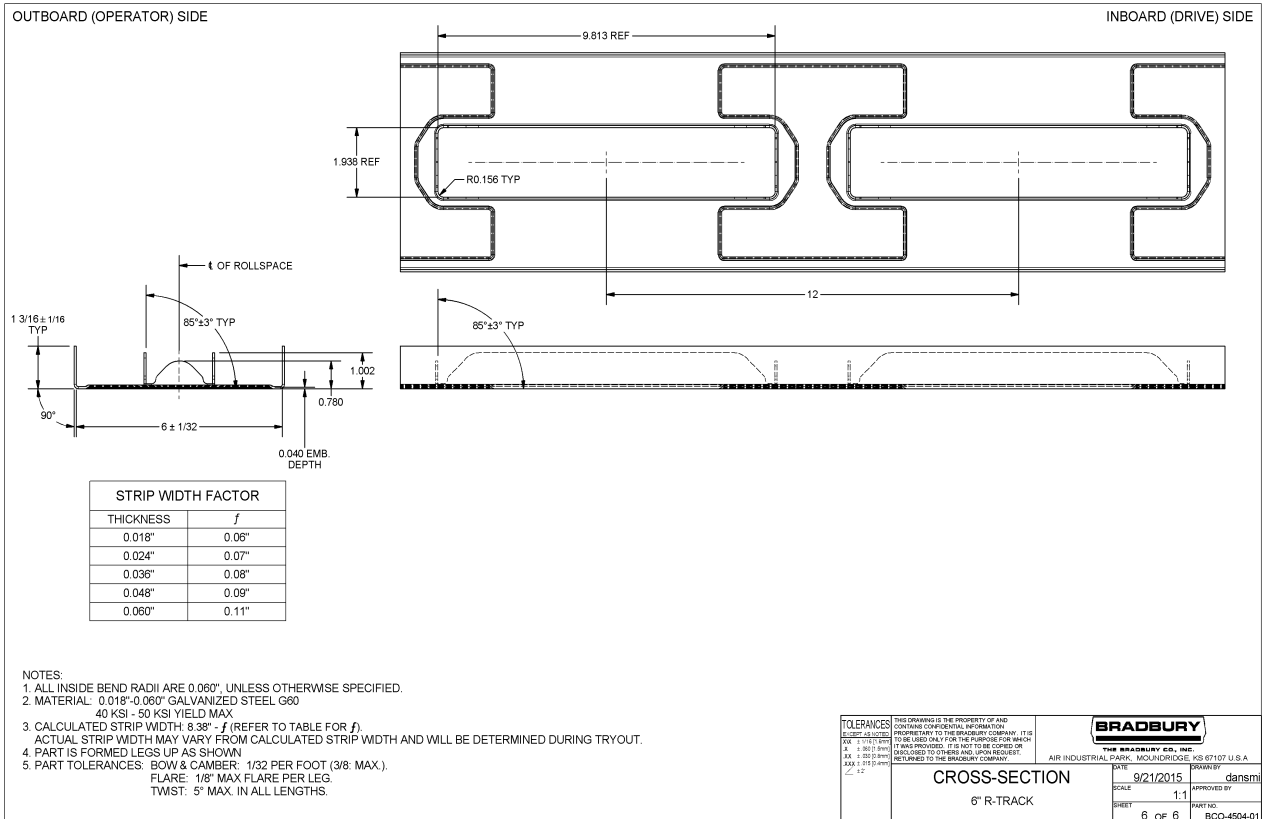

CERTIFICATE OF COMPLIANCE

Certificate Number 20180601-R39364
Report Reference R39364-20180530
Issue Date 2018-JUNE-01

Issued to: R-Stud LLC
3200 Park Center Dr
14th Floor
Costa Mesa, CA 92626 (updated address)

**This is to certify that
representative samples of**

FRAMING MEMBERS
channel-shaped steel studs designated "R-Stud" and
channel-shaped steel track designated "R-Track" intended
for use in wall assemblies..

Have been investigated by UL in accordance with the
Standard(s) indicated on this Certificate.

Standard(s) for Safety: UL 263 - Fire Tests of Building Construction and Materials
Additional Information: See the UL Online Certifications Directory at
www.ul.com/database for additional information

Only those products bearing the UL Certification Mark should be considered as being covered by UL's
Certification and Follow-Up Service.

Look for the UL Certification Mark on the product.



Bruce Mahrenholz, Director North American Certification Program
UL LLC

Any information and documentation involving UL Mark services are provided on behalf of UL LLC (UL) or any authorized licensee of UL. For questions, please
contact a local UL Customer Service Representative at <http://ul.com/aboutul/locations/>





File R39364
Project 4788356132

May 30, 2018

REPORT

on

Framing Members
(CIKV)

R-Stud LLC
Costa Mesa, CA
United States

Copyright © 2018 UL LLC

UL LLC authorizes the above named company to reproduce this Report provided it is reproduced in its entirety.

DESCRIPTION:

PRODUCT COVERED:

Framing Members - Types R-Stud and R-Track, covered in R39364, Vol. 1, Sec. 1.

GENERAL

This product is Classified as to fire resistance, and is intended for use only in specific fire resistive designs where specified in UL's Fire Resistance Directory.

Refer to UL's Fire Resistance Directory or UL's Online Certifications Directory for detailed design information and definitions relative to fire resistance design ratings and the intended use of the product covered herein.

TEST RECORD NO. 1

FIRE TEST INVESTIGATION OF LOAD BEARING WALL ASSEMBLY CONSISTING OF
3-5/8 IN. DEEP STEEL STUDS, GLASS FIBER INSULATION
AND TWO LAYERS OF 5/8 IN. UL CLASSIFIED GYPSUM BOARD

GENERAL

The following is a Report summarizing the construction details and test results of full-scale fire tests on a load bearing wall assembly consisting of steel studs, glass fiber insulation, and gypsum board.

The purpose of the investigation described herein was to develop heat transfer and physical fire performance data on a load bearing wall assembly with 5/8 in. thick UL classified gypsum board, 3-1/2 in. thick glass fiber insulation and 3-5/8 in. deep steel studs. The base and face layers of 5/8 in. UL Classified gypsum boards were installed vertically.

The tests were conducted in accordance with the Standard, Fire Tests of Building Construction and Materials, ANSI/UL263 (ASTM E119), 14th Edition, dated March 2, 2018. The test was conducted with the intent of developing data to support a 2 hr fire endurance rating for the assembly tested. The data would be used to promulgate a new design in W400 series of the UL Fire Resistance Directory.

Test results relate only to items tested.

DESCRIPTION

MATERIALS:

The materials used in the construction of the wall assemblies are described below.

Floor and Ceiling Runner - The channel-shaped steel tracks used to support the assembly along the lintel and sill of the test frame were fabricated from 0.044 in. thick galvanized steel (G60) and measured 3-5/8 in. deep with 1-15/16 in. wide flanges. All runners were supplied in 10 ft. lengths. The track supplied was identified as Type R-Track and was a proprietary shaped track produced under UL personnel witness.

Steel Studs - The C-shaped studs were fabricated from 0.044 in. thick galvanized steel and measured 3-5/8 in. deep with 1-5/8 in. long flanges and 7/8 in. long returns. The studs supplied were identified as Type R-Studs and were a proprietary shaped stud produced under UL personnel witness. Cutouts on the web of the studs were spaced 12 in. OC, were punched lengthwise on the studs. The cutouts were of a proprietary pattern which included embossed texturing of the web. All studs were supplied in 10 ft. lengths.

Glass Fiber Insulation - The unfaced glass fiber insulation was supplied in nominal 3-1/2 in. x 24 in. x 8 ft. batts and was manufactured by Owens Corning and designated R-13, Pro Pink Insulation. The outer packaging bore the UL Classification Marking for Surface Burning Characteristics. The average density of the insulation was 0.83 pcf.

Gypsum Board - The 5/8 in. thick gypsum board used were UL classified boards from various manufacturers. Information on the manufacturers used is on file internally at UL. All gypsum boards used were supplied in 4 by 12 ft. sheets before being cut into the desired sizes.

Joint Tape and Compound - The gypsum board joints were covered with 2 in. wide paper tape and both the joints and the screw heads were covered with two coats of joint compound.

Steel Fasteners - The various types and sizes of fasteners used in the construction of the wall assemblies are described in the order of use under the heading "Construction of Test Assemblies."

CONSTRUCTION OF TEST ASSEMBLIES:

Each wall assembly was constructed in accordance with methods indicated by the submitter. Each wall assembly was constructed by and under the observation of UL LLC staff.

TEST ASSEMBLY NO. 1

The floor and ceiling R-Track channels were attached to the test frame using 1 in. long by 1/4 in. diameter, No. 20 bolts.

Six R-Studs were installed in the 10 ft. high by 10 ft. wide test frame, spaced 24 in. OC. The steel studs were installed into the assembly at the 10 ft. length in which they were supplied. The R-studs were connected to the R-track flanges using a #10-1/2 in. low profile screw. The end studs were not secured to the jambs of the test frame. No bracing or bridging was installed on the studs.

On the exposed side of the assembly, two layers of 5/8 in. thick, 10 ft. long gypsum board were installed vertically. For the first layer, vertical joints were located 4 ft. and 8 ft. from the north end of the test assembly. The gypsum board was secured with 1-1/4 in. long bugle head, Type S-12 screws spaced 12 in. OC along the top and bottom tracks. The screws were also spaced 12 in. OC along the vertical edges and in the field, starting 2-1/2 in. and 12 in. from the top and bottom of the assembly.

For the second layer, vertical joints were located 2 ft. and 6 ft. from the north end of the test assembly. The gypsum board was secured with 1-7/8 in. long bugle head, Type S-12 screws spaced 12 in. OC along the top and bottom tracks. The screws were also spaced 12 in. OC along the vertical edges and in the field, starting 2 in. and 6 in. from the top and bottom of the assembly.

The glass fiber insulation batts were friction-fit in the stud cavities. The batts were supplied in 8 ft. long pieces and were placed starting at the bottom of the assembly. Five 2 ft. long pieces were cut and placed at the top of the assembly to fill in the remaining portion, resulting in a continuous insulation joint at 2 ft. from the top of the assembly.

On the unexposed side of the assembly, two layers of 5/8 in. thick, 10 ft. long gypsum wallboard were installed vertically. For the first layer, vertical joints were located 4 ft. and 8 ft. from the south end of the test assembly. The screws were spaced the same as the exposed side of the assembly.

For the second layer, vertical joints were located 2 ft. and 6 ft. from the south end of the test assembly. The screws were spaced the same as the exposed side of the assembly.

The appearance of the exposed and unexposed surfaces of the assembly before the fire endurance test is shown on ILL. 1.

TEST ASSEMBLY NO. 2

Test Assembly No. 2 was constructed in an identical manner as Test Assembly No. 1.

The appearance of the exposed and unexposed surfaces of the assembly before the duplicate hose stream test is shown on ILL. 1.

FIRE ENDURANCE TEST

TEST DATE: May 4, 2018

SAMPLE

The fire endurance test was conducted on Test Assembly No. 1 constructed as described previously in this Report under the section entitled "Construction of Test Assemblies."

METHOD

The fire test was conducted with the intent of developing data to support a 2 hr fire endurance rating for the assembly tested. Standard test equipment for wall and partition assemblies was used for the fire endurance test.

For informational purposes only, the temperatures of the steel studs were measured by 3 thermocouples as shown in ILL. 2.

The temperatures of the unexposed surface were measured by 10 thermocouples as shown in ILL. 2. Each unexposed surface thermocouple was covered with a dry ceramic fiber pad.

The pressures within the furnace chamber with respect to the laboratory were measured with stainless steel pressure probes located at the top, center and bottom portions of the test assembly.

A vertical load totaling 5,564 lb was applied to the 10 by 10 ft specimen installed in the test frame. The load application was provided by hydraulic equipment through six rams, equally spaced below the concrete sill. The ram loads pushing the concrete sill upward resulted in applying a net total vertical load of 6,811 lb, uniformly distributed along the 10 ft bottom of the specimen, after counteracting the dead load of the sill (1,247 lb). The above load was applied before conducting the test and was maintained throughout the test duration. The above loading maintained an axial load of 2003 lb per stud. This load was calculated to develop 100 percent of the maximum allowable design load on the 10 ft long, unbraced steel studs.

The horizontal deflection of the wall was determined by measurements taken along the center and quarter points at the horizontal centerline of the unexposed surface. The reference line was a fine taut metal wire fastened to both sides of the test frame. Vertical deflection of the assembly was measured using two linear voltage displacement transducers attached to the underside of the sill of the assembly at the approximate quarter points.

RESULTS

Character and Distribution of Fire - The fire was luminous and well distributed, and the furnace temperatures followed the standard time-temperature curve as outlined in the Standard ANSI/UL 263 as shown in graphical form on ILL. 3 and in tabular form in ILL. 4, Appendix A.

Pressures Within the Furnace Chamber - Within 5 minutes after the fire test started, the furnace pressure was neutral at 2/3 up the height of the wall assembly. The recorded pressures are in tabulated form in ILL. 4, Appendix B.

Observations of the Exposed and Unexposed Surfaces - The following are chronological descriptions of the observations made during the fire test. All observed dimensions are approximate.

Test Time, hr:min	Exp / Unexp	Test Observations
0:00	-	Start of test.
0:02	E	Discoloration of gypsum board.
0:08	E	Flaking of gypsum board paper.
0:15	E	No visible changes to wall assembly. Majority of joint compound still intact.
0:20	-	No measured deflection of assembly. TCs are starting to register temperature rise. TC #3 on unexposed gypsum joint is highest rise (10 F)
0:24	E	Large vertical crack in southern most gypsum board.
0:28	E	Crack is not increasing in size. No other changes to assembly.
0:32:30	UE	Light smoking from top edge of assembly.
0:38	E	Crack has not increased in size. Gypsum board is not peeling away either. Temperature rises look uniform.
0:45	E	Crack is opening up. Unexposed temperatures on that board are the highest.
0:50	-	No vertical deflection of assembly. Size of crack is about the same.
0:52	E	Gypsum board that is cracked is starting to fall away in the center area.
0:56	E	The area of the cracked gypsum board has fallen away. Approximately 1 ft wide x 6 ft tall on the bottom portion, northern edge of southern most board. The rest of the board looks flat and intact with wall.
0:58	UE	Slight inward deflection of the wall assembly.
1:06	E	Gypsum board underneath cracked piece is showing deflection and a crack is forming.
1:29	E	One stud bay is completely exposed. Still holding on temperatures and wall still maintaining load.
1:37	E	Exposed layer gypsum board is starting to go on the middle board. First layer.
1:40	E	Both layers of central board have begun to fall away. Vertical deflection of assembly still hasn't changed.
1:46	-	No changes to wall assembly.
1:48:30	-	TC #5 is approaching failure temperatures.
2:15	UE	Deflections starting to increase.
2:16	-	Test terminated.

Deflection - The horizontal deflections of the wall assembly measured during the fire test are shown in the following table:

Test Time, (hr:min)	Horizontal Deflection of Unexposed Surface (in.)		
	North	Center	South
0	0	0	0
0:10	- 1/4	- 1/4	- 1/4
0:21	- 1/4	- 1/4	- 1/4
0:31	- 1/4	- 3/16	- 3/16
0:42	- 1/4	- 1/4	- 1/4
0:50	- 5/16	- 5/8	- 9/16
1:00	- 1-13/16	- 1-7/8	- 1-9/16
1:10	- 2-1/8	- 2-7/16	- 2-1/4
1:20	- 2-3/16	- 2-1/4	- 2-1/8
1:30	- 2-3/16	- 2-3/8	- 2-1/4
1:40	- 2-5/16	- 2-5/8	- 2-5/8
1:50	- 2-3/8	- 2-11/16	- 2-13/16

Negative measurements recorded represent movement towards the fire.

Temperatures of Steel Studs - The temperatures measured on the steel studs are shown in graphical form on ILL. 3 and tabular form in ILL. 4, Appendix C.

Temperatures of the Wall Assembly - The temperatures recorded on the unexposed surface of the assembly are shown in graphical form on ILL. 3 and in tabular form in ILL. 4, Appendix C.

The initial average temperature of the unexposed surface was 75°F. Therefore, based on an average temperature rise of 250°F above ambient and a maximum individual rise of 325°F above ambient, the average limiting temperature was 325°F and the limiting individual temperature was 400°F. The individual limiting temperature was reached at 1 hr 50 min at Thermocouple No. 5. The average limiting temperature was reached at 2 hr 2 min.

Assembly Deflection - It was observed over the course of the test that the assembly deflected inwards toward the furnace, which is typical and expected of steel stud assemblies. The vertical deflection of the assembly was monitored with two linear voltage displacement transducers which were connected to the sill of the assembly. It was observed that over the course of the test, the assembly expanded, pushing the test frame sill downwards. The assembly expanded a maximum of 0.2 in. It was not until approximately 75 minutes into the test that the assembly began to deflect under the superimposed load. Despite the individual point temperature failure the test was continued to obtain data on the structural failure time. The test was terminated at 2 hr 16 min, at which point structural failure of the assembly was imminent.

Observations After the Test - Upon removal from the furnace, both exposed gypsum board layers had fallen from the exposed side of the assembly and 4 of the 5 stud bays were exposed to the furnace. The glass fiber insulation in the stud cavities had fallen out of the stud bays, allowing direct exposure to the unexposed face gypsum board. The appearance of the exposed and unexposed surfaces after the fire exposure test are shown on ILL. 1.

DUPLICATE HOSE STREAM TEST

TEST DATE: May 4, 2018

GENERAL:

In accordance with Par. 5.4.1 of the Standard ANSI/UL 263, a duplicate assembly was constructed. The performance of the fire exposure test and the hose stream test on the duplicate assembly is described herein.

FIRE ENDURANCE TEST:

SAMPLE

The fire endurance test was conducted on Test Assembly No. 2 constructed as described previously in this Report under the section entitled "Construction of Test Assemblies."

METHOD

Standard test equipment for wall and partition assemblies was used for the fire endurance and hose stream test.

The pressures within the furnace chamber with respect to the laboratory were measured with stainless steel pressure probes located at the top, center and bottom portions of the test assembly.

A vertical load totaling 5,564 lb was applied to the 10 by 10 ft specimen installed in the test frame. The load application was provided by hydraulic equipment through six rams, equally spaced below the concrete sill. The ram loads pushing the concrete sill upward resulted in applying a net total vertical load of 6,845 lb, uniformly distributed along the 10 ft bottom of the specimen, after counteracting the dead load of the sill (1,281 lb). The above load was applied before conducting the test and was maintained throughout the test duration. The above loading maintained an axial load of 2003 lb per stud. This load was calculated to develop 100 percent of the maximum allowable design load on the 10 ft long, unbraced steel studs.

RESULTS

Character and Distribution of Fire - The furnace fire was luminous and well distributed and the recorded fire temperatures followed the standard time-temperature curve as outlined in the Standard and as shown in graphical form on ILL. 5, and in tabular form in ILL. 6, Appendix A.

Pressures Within the Furnace Chamber - The furnace pressures are shown in tabular form in ILL. 6, Appendix B.

Observations During the Test - Throughout the 60 minute fire exposure, Test Assembly No. 2 had a similar appearance as the first 60 minutes of the fire exposure of Test Assembly No. 1.

HOSE STREAM TEST:

Immediately following the fire exposure test, the test assembly was removed from the furnace and moved into position for the hose stream test. The assembly was subjected to the impact, cooling and eroding action of a hose stream applied to the exposed surface of the test assembly. The hose stream test was conducted within 5 minutes after the fire exposure test was terminated.

METHOD

The hose stream test was conducted in accordance with the Standard, ANSI/UL 263. Based on a 2 hr fire endurance rating, the Standard requires the test assembly to be subjected to the action of a 30 psi hose stream applied for a duration of 2-1/2 min. The hose stream was applied with a 1-1/8 in. diameter nozzle at a perpendicular distance of 20 ft from the center of the test assembly. The hose stream was applied to the 100 ft² sample and traversed the wall assembly.

RESULTS

The first few passes of the hose stream washed away the gypsum board on the exposed side and the stud cavity insulation. No through projection of water was observed beyond the unexposed surface of the wall assembly after 2-1/2 min of hose stream exposure.

Observations After the Test - The appearance of the exposed and unexposed surfaces of the wall assembly after the fire exposure and hose stream tests is shown in ILL 1.

ENGINEERING STUDY

The intent of this test program was to obtain data that would support classification of the proprietary shaped studs and track, identified as R-Stud and R-Track, under the classification category for Framing Members (CIKV). The assembly tested was intended to develop data to support promulgation of a design for a 2 hr load-bearing wall assembly with the inclusion of the classified framing members.

The data in this report shows that the fire endurance test yielded a 1 hr 50 min fire endurance rating with the failure mode being individual point temperature failure. Despite the individual point temperature failure, the average temperature criterion was not exceeded prior to 2 hr, and the assembly was able to maintain the superimposed load for a period of 2 hr 16 min, despite the individual point temperature rise being exceeded prior to 2 hr.

Through analysis of the test data and visual observations it is the determination of UL LLC that the assembly exceeding the maximum allowable individual temperature rise criterion was unrelated to the studs used in the test assembly. Furthermore, even with the temperature rise being exceeded, the assembly still maintained the load for a period greater than 2 hr. Further explanation on this determination is on file internally. As such, the classification will be granted to the R-studs and R-Track, and a design will be promulgated in the online directory for the tested assembly.

CONCLUSIONS

The following conclusions represent the judgment of UL LLC based upon the examinations and tests presented in this Report, as they relate to established principles and previously recorded data.

FIRE RESISTANCE PROPERTIES

It is judged that a load bearing wall and partition assembly constructed of the materials and in the manner described herein will afford 2 hr protection against the passage of flame and dangerous transmission of heat, respectively, when exposed to fire from either side of the assembly.

The above Classification is based on "Conditions of Acceptance" for tests of non-load bearing walls and partitions as specified in the Standard, Fire Tests of Building Construction and Materials, UL 263 (ASTM E119), 14th Edition, dated March 2, 2018.

The results from these tests will be incorporated into new UL Design No. W464.

PRACTICABILITY:

The materials used in the test assemblies were readily installed by qualified workmen with tools and methods commonly used for constructions of this nature.

Materials and procedures, in accordance with those described in this Report, are considered significant factors in the fire resistance of the construction.

CONFORMITY:

The assembly was tested in accordance with the Standard, Fire Tests of Building Construction and Materials, ANSI/UL 263 (ASTM E119).

TEST RECORD SUMMARY

The results of this investigation including construction review and testing indicate that the products evaluated comply with the applicable requirements in the standard noted below and, therefore, such products are judged eligible to bear UL's Mark as described on the Conclusion Page of this Report.

Standard	Title	Edition or Publication Date	Revision Date
UL 263	Fire Tests of Building Construction and Materials	14	March 2, 2018

Test Record by:

DAVID HINTZ
Senior Project Engineer

Reviewed By:

KEVIN R. HYLAND
Staff Engineer

Any information and documentation involving UL Mark services are provided on behalf of UL LLC or any authorized licensee of UL.

CONCLUSION:

Samples of the product covered by this Report have been found to comply with the requirements covering the category and the product is found to comply with UL's applicable requirements. The description and test result in this Report are only applicable to the samples investigated by UL and does not signify UL certification or that the product described is covered under UL's Follow-Up Service Program. When covered under UL's Follow-Up Service Program, the manufacturer is authorized to use the UL Classification Mark on such products which comply with UL's Follow-Up Service Procedure and any other application requirements of UL LLC. The Classification Mark of UL LLC on the product, or the UL symbol on the product and the Classification Mark on the smallest unit container in which the product is packaged, is the only method to identify products investigated by UL to published requirements and manufactured under UL's Classification and Follow-Up Service.

This Report is intended solely for the use of UL and the Applicant for establishment of UL certification coverage of the product under UL's Follow-Up Service. UL retains all rights, title and interest (including exclusive ownership) in this Report and all copyright therein. Unless expressly authorized in writing by UL, the Applicant shall not disclose or otherwise distribute this Report or its contents to any third party or use this Report for any purpose other than to establish UL certification and become eligible for Follow-Up Service for the product described in this Report. Any other use of this Report including without limitation, evaluation or certification by a party other than UL unless part of a certification scheme, is prohibited and renders the Report null and void. UL shall not incur any obligation or liability for any loss, expense, or punitive damages, arising out of or in connection with the use or reliance upon the contents of this Report to anyone other than the Applicant as provided in the agreement between UL and Applicant. Any use or reference to UL's name or certification mark(s) by anyone other than the Applicant in accordance with the agreement is prohibited without the express written approval of UL. Any information and documentation provided to you involving UL Mark services are provided on behalf of UL LLC or any authorized licensee of UL. UL shall not otherwise be responsible to anyone for the use of or reliance upon the contents of this Report.

Report by:

DAVID HINTZ
Senior Project Engineer

Reviewed by:

KEVIN R. HYLAND
Staff Engineer



Endurance Assembly – Exposed Face – Pretest

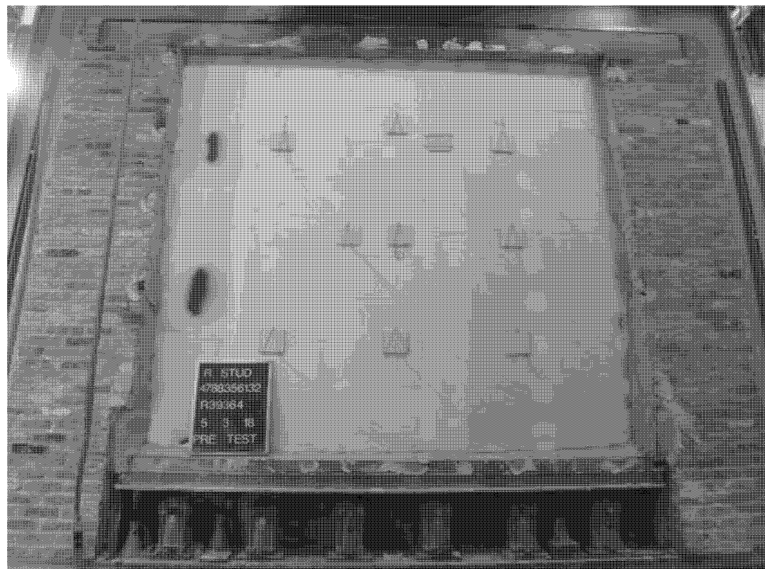

Endurance Assembly – Unexposed Face - Pretest



Endurance Assembly – Exposed Face – Post Test

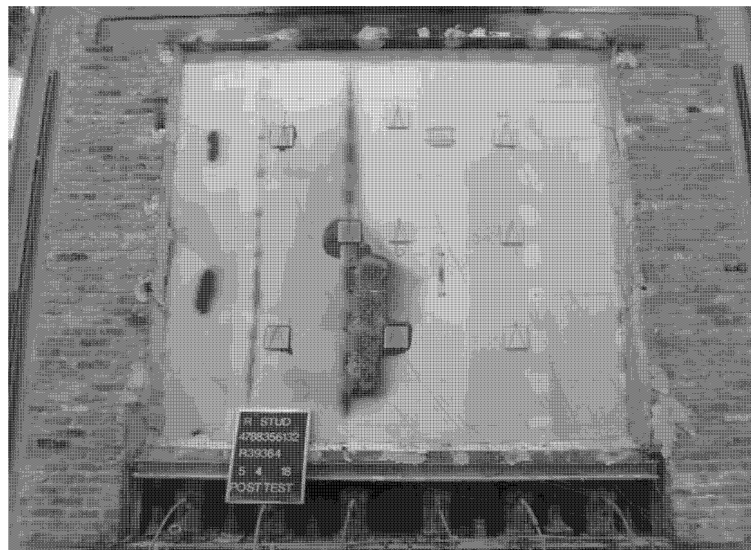

Endurance Assembly – Unexposed Face – Post Test

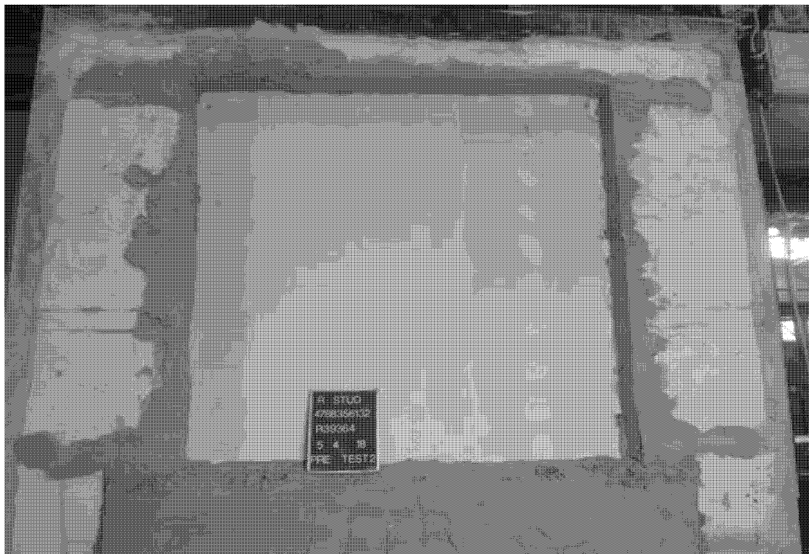

Hose Stream Duplicate – Exposed Face - Pretest



Hose Stream Duplicate – Unexposed Face - Pretest

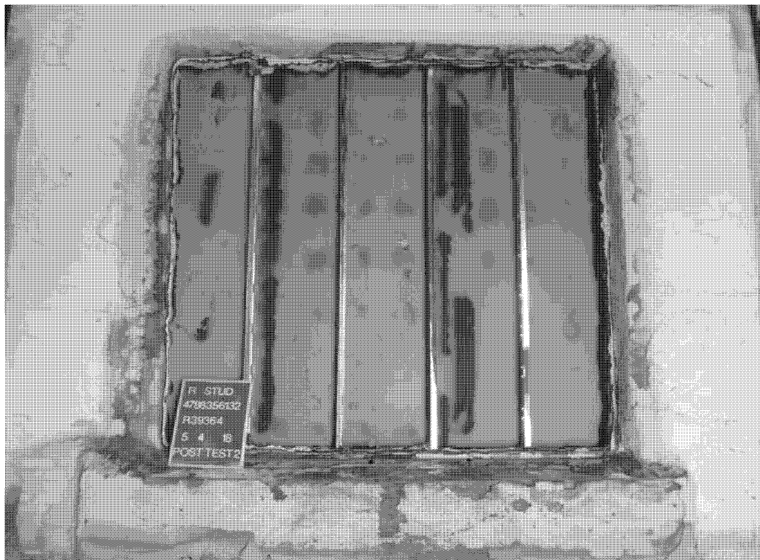

Hose Stream Duplicate – Exposed Face – Post Test

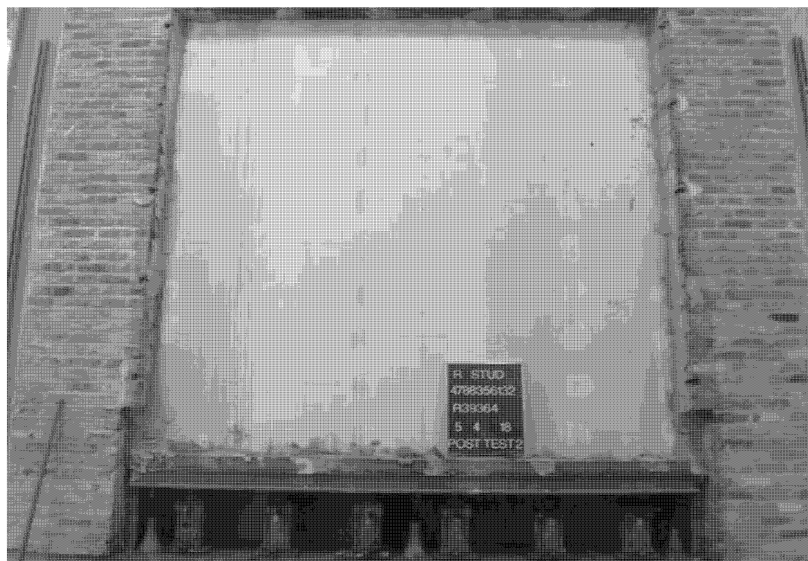

Hose Stream Duplicate – Unexposed Face – Post Test

Fire Endurance Assembly Thermocouple Layout

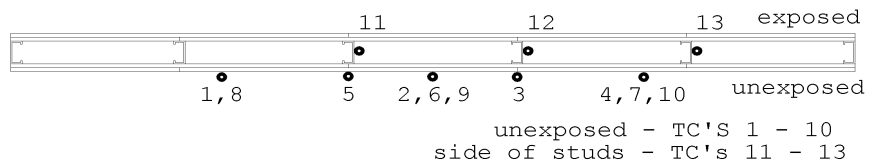
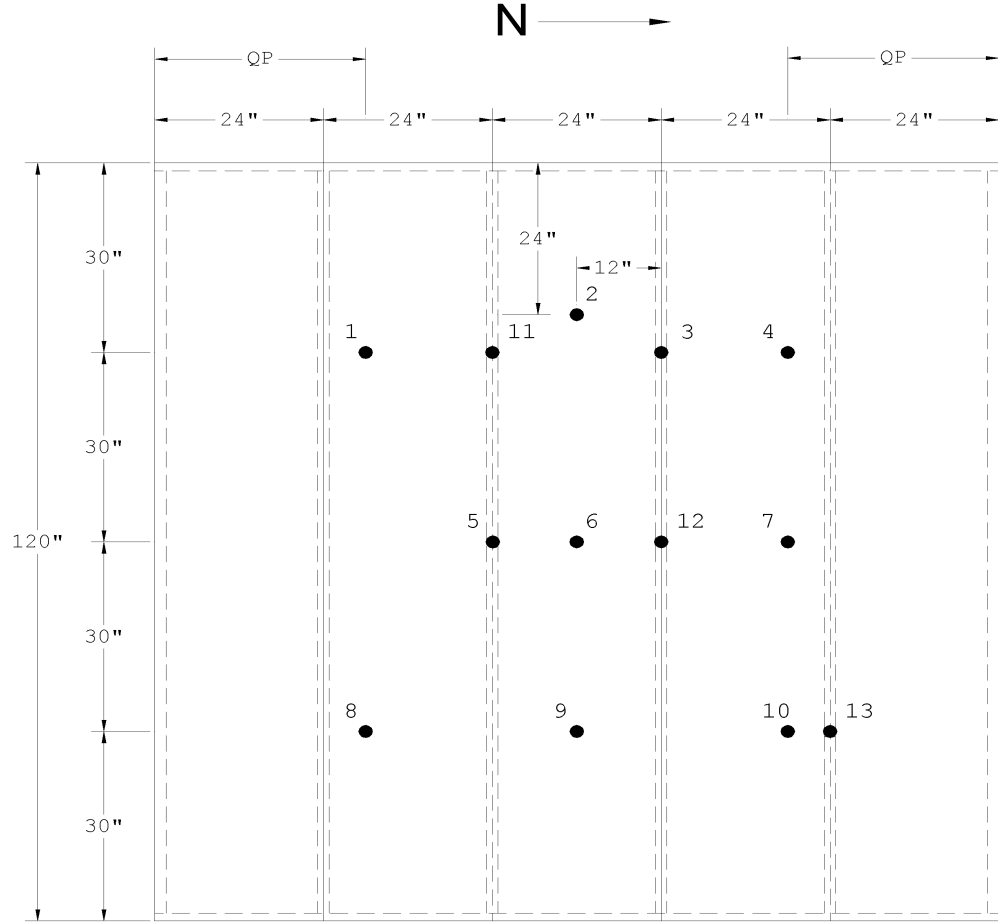

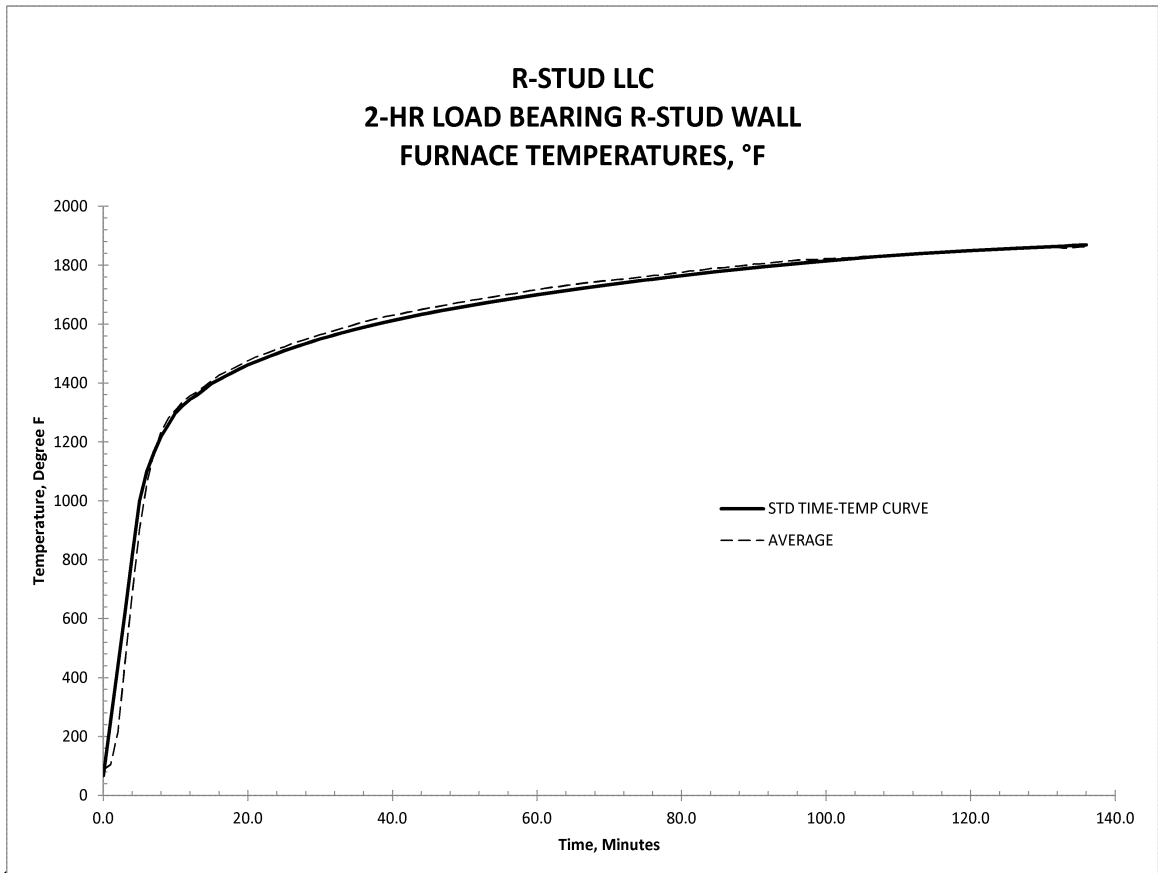

4788356132/4788356132

Test Date: 2018-05-04

\\4788356132 - Processed Data

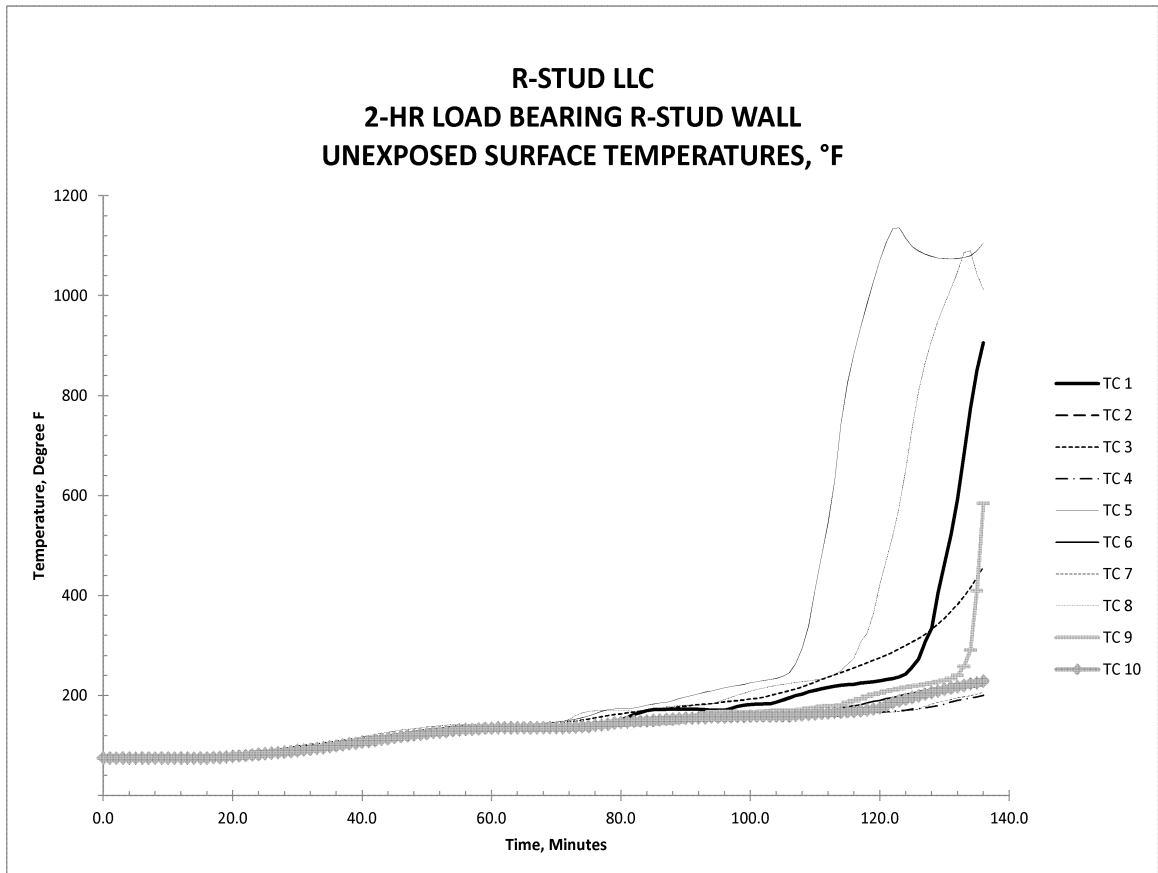

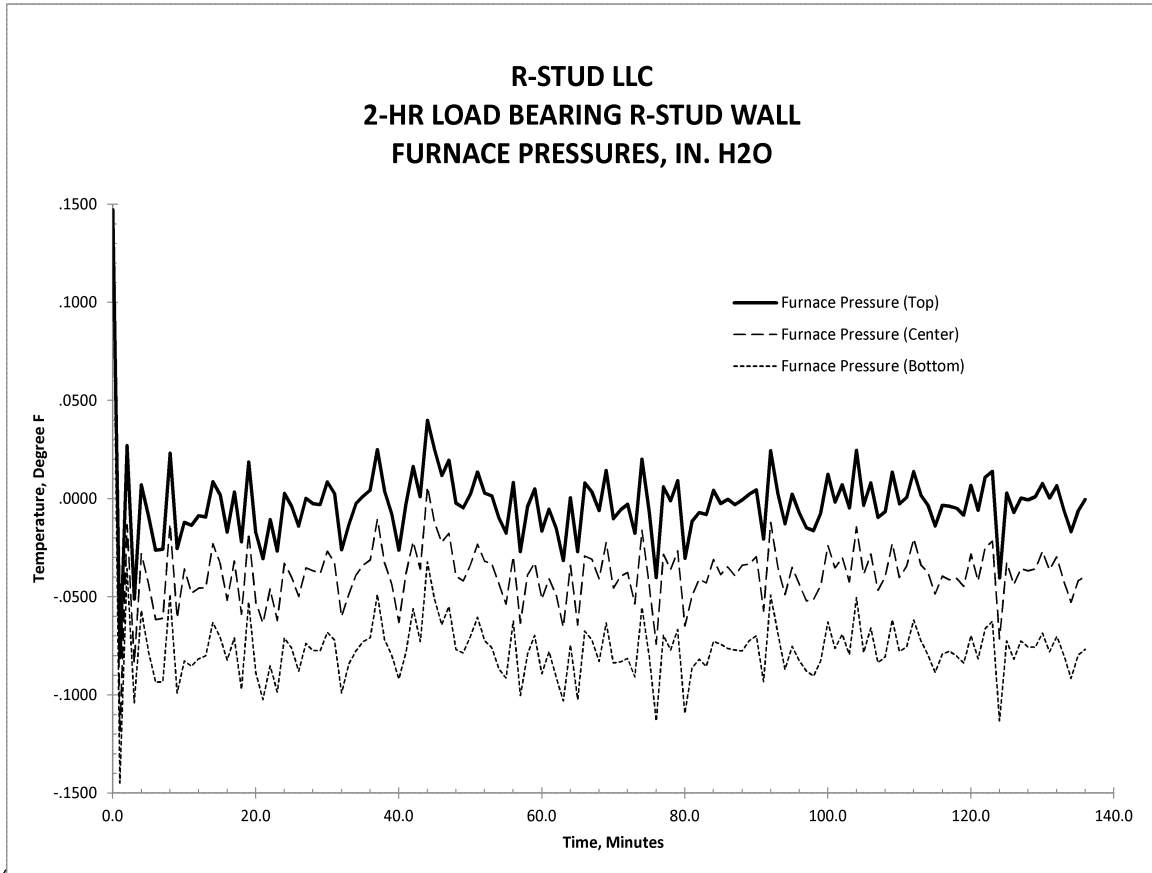

4788356132/180504

Test Date: 2018-05-04

\\4788356132 - Processed Data

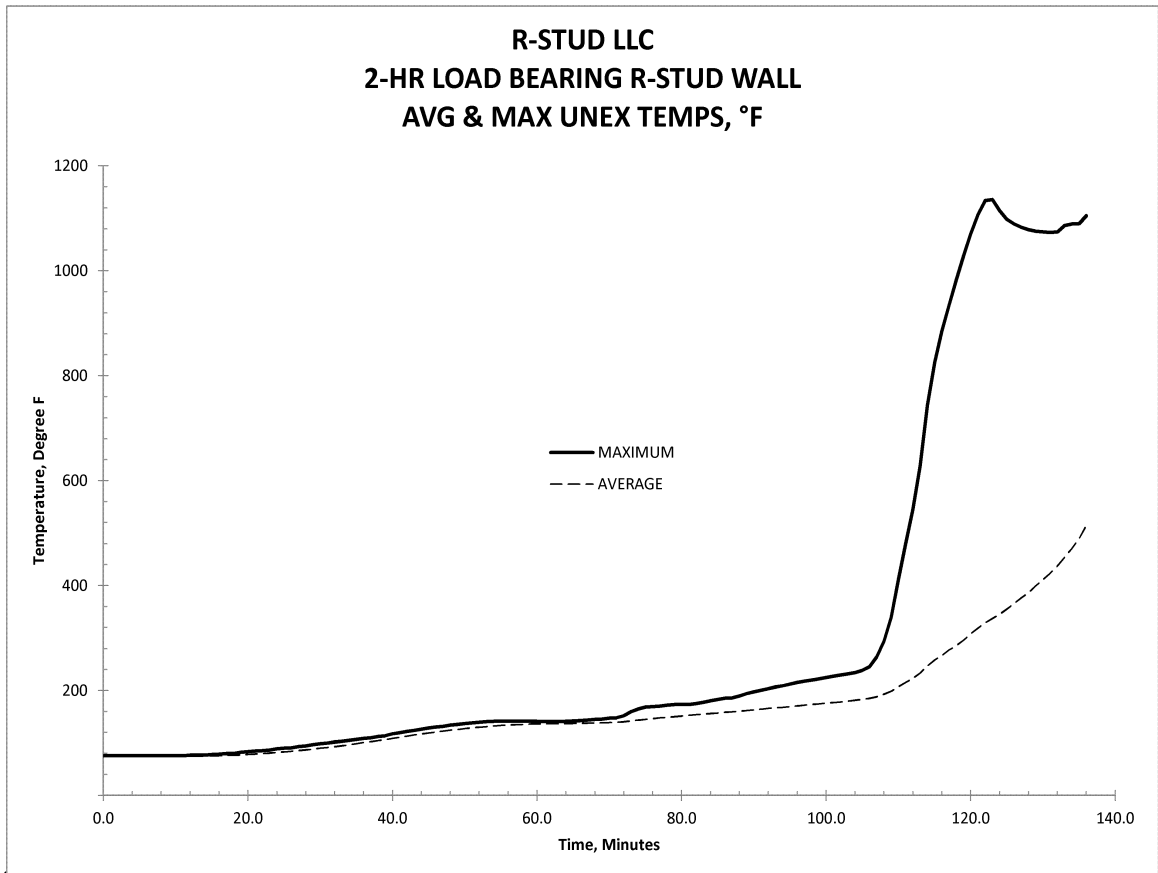

4788356132/4788356132

Test Date: 2018-05-04

\\4788356132 - Processed Data

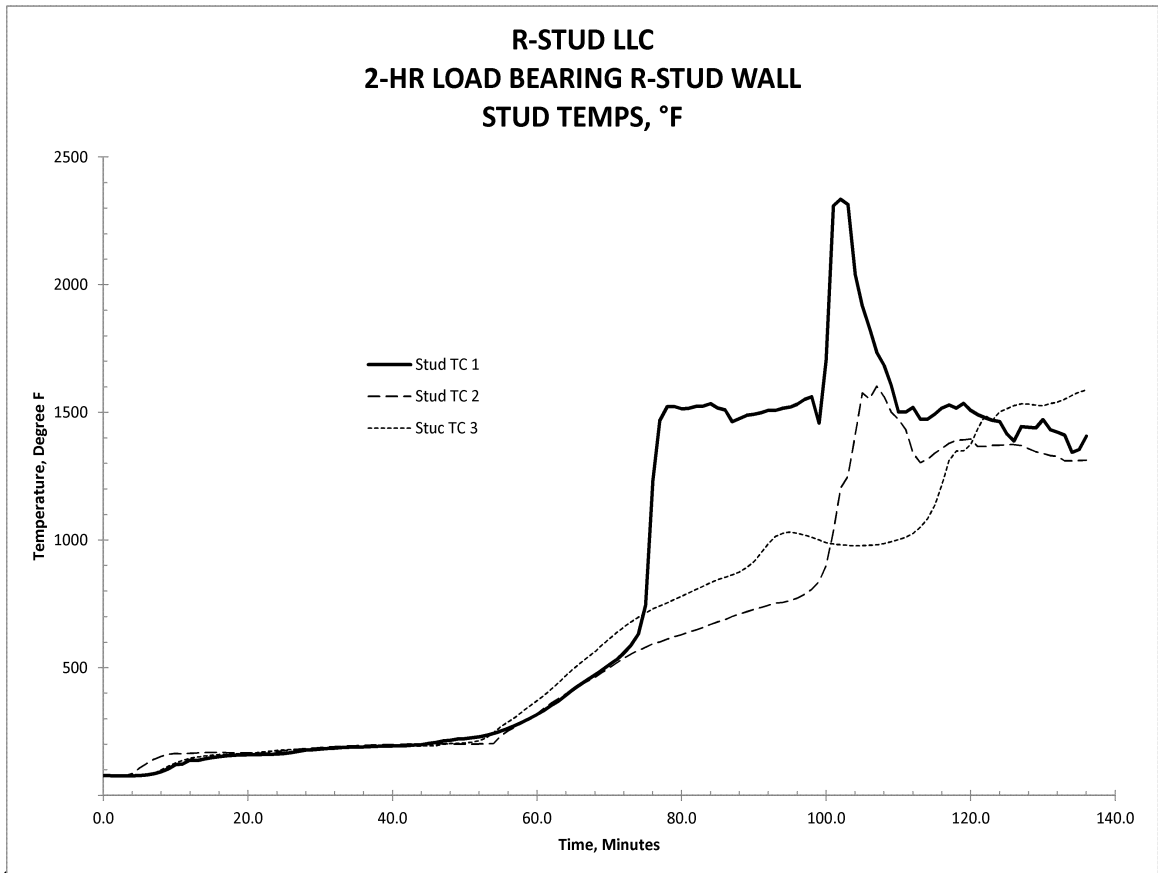

4788356132/4788356132

Test Date: 2018-05-04

\\4788356132 - Processed Data

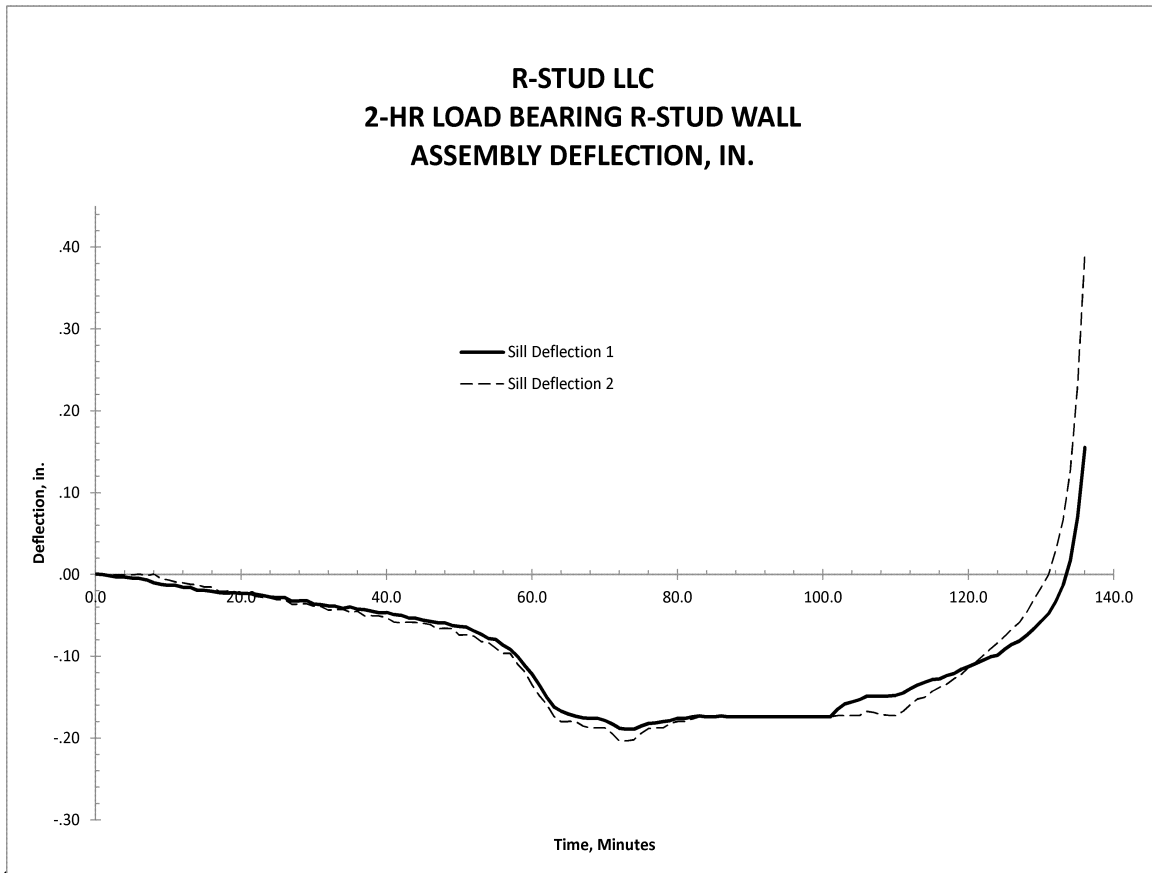

4788356132/4788356132
Test Date: 2018-05-04
\\4788356132 - Processed Data

FILE R39364

APPENDIX A

R-STUD LLC
 2-HR LOAD BEARING R-STUD WALL
 4788356132/R39364
 Test Date: 2018-05-04

FURNACE TEMPERATURES, °F

Time hr:min:sec	Time	STD TIME-	Furn. TC #1	Furn. TC #2	Furn. TC #3	Furn. TC #4	Furn. TC #5
		TEMP CURVE					
0:00:00	0.0	68.0	89.6	89.8	90.7	88.5	89.4
0:01:00	1.0	254.4	111.9	107.6	113.7	104.7	105.3
0:02:00	2.0	440.8	232.5	216.7	276.8	204.4	222.3
0:03:00	3.0	627.2	469.4	470.3	600.3	419.5	488.1
0:04:00	4.0	813.6	722.8	713.7	822.4	668.5	739.4
0:05:00	5.0	1000.0	934.9	904.3	975.0	898.5	954.3
0:06:00	6.0	1100.0	1068.4	1048.8	1089.3	1059.4	1101.4
0:07:00	7.0	1165.0	1148.7	1150.7	1177.2	1162.8	1200.0
0:08:00	8.0	1220.0	1201.8	1221.1	1241.4	1227.4	1270.8
0:09:00	9.0	1260.0	1241.2	1265.0	1281.0	1266.4	1310.5
0:10:00	10.0	1300.0	1272.0	1292.2	1304.1	1293.3	1331.6
0:11:00	11.0	1325.0	1296.0	1314.3	1328.5	1320.6	1357.2
0:12:00	12.0	1345.0	1315.8	1328.7	1343.5	1339.9	1372.5
0:13:00	13.0	1360.0	1334.8	1344.6	1357.7	1359.7	1387.0
0:14:00	14.0	1380.0	1355.5	1360.8	1376.1	1380.0	1404.0
0:15:00	15.0	1399.0	1378.6	1378.2	1395.7	1402.2	1421.8
0:16:00	16.0	1412.0	1398.4	1399.1	1417.5	1420.3	1440.5
0:17:00	17.0	1425.0	1409.2	1416.9	1430.2	1431.3	1451.8
0:18:00	18.0	1437.0	1422.1	1433.5	1445.7	1445.0	1463.5
0:19:00	19.0	1450.0	1436.2	1448.8	1459.2	1458.0	1475.4
0:20:00	20.0	1462.0	1448.2	1463.5	1472.0	1472.0	1488.0
0:21:00	21.0	1471.6	1460.7	1478.3	1484.6	1485.1	1499.2
0:22:00	22.0	1481.2	1467.9	1490.9	1494.7	1493.6	1508.4
0:23:00	23.0	1490.8	1476.9	1502.8	1503.9	1501.5	1515.9
0:24:00	24.0	1500.4	1488.9	1512.5	1515.6	1512.0	1523.5
0:25:00	25.0	1510.0	1499.9	1517.2	1523.1	1522.4	1530.5
0:26:00	26.0	1518.0	1513.0	1526.7	1532.7	1535.0	1540.6
0:27:00	27.0	1526.0	1522.2	1533.6	1539.5	1544.4	1547.6
0:28:00	28.0	1534.0	1530.5	1540.9	1547.8	1552.5	1555.7
0:29:00	29.0	1542.0	1537.5	1548.1	1554.8	1559.5	1564.0
0:30:00	30.0	1550.0	1544.9	1558.0	1564.0	1568.1	1573.2
0:31:00	31.0	1556.8	1552.6	1566.5	1569.7	1574.8	1580.0
0:32:00	32.0	1563.6	1561.5	1574.6	1576.6	1582.2	1588.1
0:33:00	33.0	1570.4	1569.2	1581.3	1582.7	1589.5	1594.8
0:34:00	34.0	1577.2	1576.2	1588.3	1587.4	1595.5	1600.3
0:35:00	35.0	1584.0	1584.1	1595.5	1595.5	1604.1	1609.3
0:36:00	36.0	1589.8	1590.1	1602.9	1603.2	1610.2	1617.1
0:37:00	37.0	1595.6	1597.3	1609.0	1609.3	1615.8	1621.8
0:38:00	38.0	1601.4	1603.2	1614.9	1614.2	1621.8	1626.3
0:39:00	39.0	1607.2	1610.1	1621.8	1618.9	1627.9	1631.8

FILE R39364

APPENDIX A

R-STUD LLC
 2-HR LOAD BEARING R-STUD WALL
 4788356132/R39364
 Test Date: 2018-05-04

FURNACE TEMPERATURES, °F

Time hr:min:sec	Time	STD TIME-	Furn. TC #1	Furn. TC #2	Furn. TC #3	Furn. TC #4	Furn. TC #5
		TEMP CURVE					
0:40:00	40.0	1613.0	1614.4	1626.4	1623.7	1632.6	1636.7
0:41:00	41.0	1618.0	1617.6	1629.7	1628.2	1636.2	1641.6
0:42:00	42.0	1623.0	1622.7	1636.7	1634.0	1641.7	1647.3
0:43:00	43.0	1628.0	1627.3	1640.1	1637.4	1646.6	1650.7
0:44:00	44.0	1633.0	1632.7	1644.8	1643.4	1651.3	1656.3
0:45:00	45.0	1638.0	1637.4	1649.1	1648.0	1656.1	1661.4
0:46:00	46.0	1642.6	1641.9	1653.4	1652.4	1659.4	1664.8
0:47:00	47.0	1647.2	1646.4	1658.1	1656.9	1664.2	1669.5
0:48:00	48.0	1651.8	1651.3	1661.7	1660.3	1667.8	1674.3
0:49:00	49.0	1656.4	1655.8	1666.4	1666.0	1672.9	1679.7
0:50:00	50.0	1661.0	1659.4	1670.0	1669.8	1677.4	1684.4
0:51:00	51.0	1665.0	1664.4	1675.6	1675.2	1682.1	1689.3
0:52:00	52.0	1669.0	1667.8	1679.4	1677.6	1685.5	1692.9
0:53:00	53.0	1673.0	1672.2	1682.6	1682.1	1689.1	1696.3
0:54:00	54.0	1677.0	1676.5	1686.9	1686.6	1692.3	1698.4
0:55:00	55.0	1681.0	1679.9	1690.3	1690.9	1697.0	1703.8
0:56:00	56.0	1684.8	1683.3	1695.0	1694.1	1700.4	1708.2
0:57:00	57.0	1688.6	1687.8	1698.3	1697.5	1703.8	1711.8
0:58:00	58.0	1692.4	1691.2	1701.7	1702.2	1708.2	1716.3
0:59:00	59.0	1696.2	1695.2	1706.5	1706.5	1713.0	1722.2
1:00:00	60.0	1700.0	1699.5	1710.3	1710.9	1716.3	1725.6
1:01:00	61.0	1703.6	1704.2	1714.6	1714.3	1720.6	1729.6
1:02:00	62.0	1707.2	1707.8	1717.9	1716.8	1723.8	1733.0
1:03:00	63.0	1710.8	1710.1	1721.1	1719.1	1726.0	1735.2
1:04:00	64.0	1714.4	1715.0	1724.7	1724.4	1730.7	1738.6
1:05:00	65.0	1718.0	1717.3	1728.3	1727.6	1732.8	1740.9
1:06:00	66.0	1721.4	1721.7	1730.7	1730.8	1737.1	1744.2
1:07:00	67.0	1724.8	1724.9	1735.2	1733.2	1740.7	1746.7
1:08:00	68.0	1728.2	1728.5	1737.3	1735.3	1742.9	1747.8
1:09:00	69.0	1731.6	1731.0	1740.9	1738.6	1747.6	1749.9
1:10:00	70.0	1735.0	1734.3	1742.0	1739.7	1748.7	1751.2
1:11:00	71.0	1738.0	1737.5	1746.7	1744.0	1753.3	1756.9
1:12:00	72.0	1741.0	1740.9	1749.9	1745.2	1755.5	1758.2
1:13:00	73.0	1744.0	1743.4	1752.1	1748.5	1758.7	1756.8
1:14:00	74.0	1747.0	1747.8	1755.7	1754.6	1762.0	1753.0
1:15:00	75.0	1750.0	1751.4	1759.3	1756.0	1765.2	1751.9
1:16:00	76.0	1753.0	1754.1	1761.4	1759.6	1767.4	1756.8
1:17:00	77.0	1756.0	1755.1	1763.6	1760.7	1769.5	1756.8
1:18:00	78.0	1759.0	1759.6	1767.0	1760.7	1773.1	1760.0
1:19:00	79.0	1762.0	1764.0	1771.9	1762.9	1776.7	1764.5

FILE R39364

APPENDIX A

R-STUD LLC
 2-HR LOAD BEARING R-STUD WALL
 4788356132/R39364
 Test Date: 2018-05-04

FURNACE TEMPERATURES, °F

Time hr:min:sec	Time	STD TIME-	Furn. TC #1	Furn. TC #2	Furn. TC #3	Furn. TC #4	Furn. TC #5
		TEMP CURVE					
1:20:00	80.0	1765.0	1766.1	1775.1	1765.4	1778.9	1765.6
1:21:00	81.0	1767.8	1771.0	1779.6	1769.9	1783.2	1770.4
1:22:00	82.0	1770.6	1772.1	1782.1	1772.1	1784.3	1771.7
1:23:00	83.0	1773.4	1775.7	1785.7	1775.3	1787.5	1775.3
1:24:00	84.0	1776.2	1779.3	1789.2	1779.8	1792.4	1781.4
1:25:00	85.0	1779.0	1781.4	1791.5	1782.1	1793.5	1785.9
1:26:00	86.0	1781.6	1783.8	1793.7	1783.4	1795.6	1789.5
1:27:00	87.0	1784.2	1785.9	1796.0	1786.6	1798.9	1792.8
1:28:00	88.0	1786.8	1789.3	1798.2	1789.0	1801.0	1796.0
1:29:00	89.0	1789.4	1791.7	1801.8	1792.4	1803.2	1798.5
1:30:00	90.0	1792.0	1794.9	1805.2	1795.6	1807.5	1803.0
1:31:00	91.0	1794.4	1797.3	1807.3	1796.9	1808.6	1804.3
1:32:00	92.0	1796.8	1798.3	1809.7	1799.2	1810.8	1806.6
1:33:00	93.0	1799.2	1801.8	1812.9	1802.5	1814.0	1810.4
1:34:00	94.0	1801.6	1805.0	1815.1	1805.2	1816.3	1812.7
1:35:00	95.0	1804.0	1807.2	1817.4	1807.3	1818.5	1816.0
1:36:00	96.0	1806.2	1809.5	1820.7	1810.6	1820.8	1818.1
1:37:00	97.0	1808.4	1811.7	1821.7	1811.7	1823.0	1819.2
1:38:00	98.0	1810.6	1811.7	1822.8	1811.7	1823.0	1819.2
1:39:00	99.0	1812.8	1815.1	1825.3	1814.9	1826.2	1821.4
1:40:00	100.0	1815.0	1817.2	1828.8	1817.1	1828.4	1821.4
1:41:00	101.0	1817.2	1818.7	1829.8	1819.2	1828.4	1822.5
1:42:00	102.0	1819.4	1818.7	1830.9	1819.2	1828.4	1821.4
1:43:00	103.0	1821.6	1819.8	1832.0	1821.6	1829.7	1821.4
1:44:00	104.0	1823.8	1822.1	1833.1	1823.7	1832.0	1822.5
1:45:00	105.0	1826.0	1825.7	1836.5	1827.1	1835.2	1825.7
1:46:00	106.0	1827.8	1826.8	1836.5	1827.1	1836.3	1826.8
1:47:00	107.0	1829.6	1828.9	1838.7	1830.4	1838.5	1827.9
1:48:00	108.0	1831.4	1831.1	1840.8	1832.7	1839.6	1831.1
1:49:00	109.0	1833.2	1833.3	1843.2	1833.8	1841.7	1833.3
1:50:00	110.0	1835.0	1835.8	1844.2	1835.1	1844.1	1834.3
1:51:00	111.0	1836.6	1836.9	1845.3	1835.1	1845.1	1835.4
1:52:00	112.0	1838.2	1839.0	1847.5	1837.2	1847.3	1838.7
1:53:00	113.0	1839.8	1841.2	1850.7	1840.6	1850.5	1843.2
1:54:00	114.0	1841.4	1842.4	1851.8	1841.9	1851.6	1844.2
1:55:00	115.0	1843.0	1842.4	1851.8	1841.9	1851.6	1844.2
1:56:00	116.0	1844.4	1843.5	1851.8	1844.2	1851.6	1845.3
1:57:00	117.0	1845.8	1847.3	1855.2	1848.9	1854.0	1850.5
1:58:00	118.0	1847.2	1848.4	1858.8	1850.0	1856.5	1852.7
1:59:00	119.0	1848.6	1849.5	1859.9	1850.0	1856.5	1854.0

FILE R39364

APPENDIX A

R-STUD LLC
 2-HR LOAD BEARING R-STUD WALL
 4788356132/R39364
 Test Date: 2018-05-04

FURNACE TEMPERATURES, °F

Time hr:min:sec	Time	STD TIME-	Furn. TC #1	Furn. TC #2	Furn. TC #3	Furn. TC #4	Furn. TC #5
		TEMP CURVE					
2:00:00	120.0	1850.0	1850.5	1859.9	1852.2	1857.6	1855.0
2:01:00	121.0	1851.3	1851.6	1861.0	1853.6	1859.0	1857.2
2:02:00	122.0	1852.5	1852.7	1863.3	1854.9	1860.3	1858.3
2:03:00	123.0	1853.8	1854.0	1863.3	1854.9	1861.3	1858.3
2:04:00	124.0	1855.0	1856.5	1864.6	1857.0	1862.4	1860.4
2:05:00	125.0	1856.3	1856.5	1864.6	1858.1	1863.9	1861.5
2:06:00	126.0	1857.5	1857.6	1866.7	1859.4	1863.9	1862.6
2:07:00	127.0	1858.8	1858.6	1866.7	1859.4	1864.9	1862.6
2:08:00	128.0	1860.0	1859.7	1868.0	1860.4	1866.2	1864.9
2:09:00	129.0	1861.3	1861.0	1869.1	1861.7	1868.4	1864.9
2:10:00	130.0	1862.0	1862.1	1869.1	1861.7	1869.4	1864.9
2:11:00	131.0	1863.3	1863.1	1871.2	1863.9	1870.5	1866.0
2:12:00	132.0	1864.5	1862.6	1870.0	1862.8	1867.8	1864.8
2:13:00	133.0	1865.8	1860.3	1862.1	1863.9	1847.7	1860.3
2:14:00	134.0	1867.0	1864.6	1863.1	1867.5	1845.5	1861.7
2:15:00	135.0	1868.3	1869.1	1867.6	1870.9	1852.5	1864.4
2:16:00	136.0	1869.5	1871.2	1869.8	1874.3	1857.9	1866.7

FILE R39364

APPENDIX A

R-STUD LLC
 2-HR LOAD BEARING R-STUD WALL
 4788356132/R39364
 Test Date: 2018-05-04

FURNACE TEMPERATURES, °F

Time hr:min:sec	Furn. TC #6	Furn. TC #7	Furn. TC #8	Furn. TC #9	Furn. TC #10	Furn. TC #11	Furn. TC #12	AVERAGE
0:00:00	88.5	88.7	87.3	86.9	86.2	87.3	83.7	88.0
0:01:00	108.7	101.7	107.1	104.7	101.8	97.9	91.6	104.7
0:02:00	234.3	209.7	225.3	226.0	194.2	184.8	155.8	215.2
0:03:00	512.8	439.7	479.8	497.3	377.1	386.2	306.0	453.9
0:04:00	756.1	695.8	732.2	740.1	592.9	615.6	478.6	689.8
0:05:00	930.9	942.8	961.9	937.6	841.5	857.8	703.6	903.6
0:06:00	1061.1	1100.5	1109.1	1086.8	1030.6	1035.3	914.2	1058.8
0:07:00	1152.7	1194.1	1209.7	1193.5	1150.0	1165.1	1069.3	1164.5
0:08:00	1220.4	1251.5	1275.1	1273.5	1231.3	1241.6	1182.9	1236.6
0:09:00	1264.8	1287.5	1313.4	1319.2	1285.9	1289.3	1255.3	1281.6
0:10:00	1295.4	1313.1	1335.2	1342.4	1321.9	1319.2	1291.1	1309.3
0:11:00	1324.8	1346.4	1363.8	1364.9	1365.4	1346.9	1330.2	1338.2
0:12:00	1340.1	1367.6	1381.8	1376.2	1398.6	1362.6	1351.0	1356.5
0:13:00	1353.7	1381.8	1393.3	1381.6	1418.7	1377.1	1362.7	1371.1
0:14:00	1374.4	1401.6	1409.2	1393.2	1438.3	1395.1	1379.3	1389.0
0:15:00	1397.8	1421.1	1425.7	1409.0	1457.6	1416.0	1398.4	1408.5
0:16:00	1418.9	1439.1	1440.5	1426.3	1474.7	1433.7	1417.6	1427.2
0:17:00	1430.1	1449.3	1450.2	1438.0	1483.9	1444.5	1427.4	1438.6
0:18:00	1442.7	1459.0	1458.5	1448.2	1492.7	1456.7	1438.3	1450.5
0:19:00	1456.2	1468.4	1469.3	1461.6	1502.1	1469.8	1455.4	1463.4
0:20:00	1468.6	1479.0	1482.1	1473.3	1513.4	1482.6	1468.6	1475.9
0:21:00	1479.9	1490.2	1490.7	1486.4	1524.0	1494.5	1481.5	1487.9
0:22:00	1489.1	1498.8	1497.6	1494.3	1531.8	1503.9	1488.0	1496.6
0:23:00	1498.3	1508.7	1504.6	1502.8	1539.3	1514.3	1497.6	1505.5
0:24:00	1506.6	1518.8	1512.9	1513.4	1547.6	1524.7	1509.3	1515.5
0:25:00	1513.6	1529.4	1520.1	1521.0	1553.7	1525.8	1517.0	1522.8
0:26:00	1522.0	1544.0	1531.2	1534.6	1561.3	1532.5	1528.5	1533.5
0:27:00	1529.4	1551.9	1539.5	1542.7	1567.0	1535.2	1536.3	1540.8
0:28:00	1538.1	1560.6	1548.0	1550.7	1573.0	1543.5	1545.6	1548.9
0:29:00	1544.9	1567.2	1555.3	1558.4	1580.9	1550.5	1552.3	1556.1
0:30:00	1553.4	1574.1	1565.8	1563.1	1590.6	1560.6	1559.3	1564.6
0:31:00	1560.0	1579.8	1573.0	1567.4	1595.7	1568.8	1562.5	1570.9
0:32:00	1567.0	1587.4	1580.9	1575.5	1601.2	1580.4	1570.6	1578.8
0:33:00	1574.1	1594.2	1589.4	1583.8	1606.3	1589.7	1577.8	1586.1
0:34:00	1580.0	1601.6	1596.0	1591.2	1610.6	1598.4	1582.2	1592.3
0:35:00	1588.6	1610.1	1604.8	1600.3	1618.2	1608.6	1589.7	1600.7
0:36:00	1595.8	1617.1	1611.9	1609.9	1625.4	1616.5	1597.6	1608.1
0:37:00	1603.2	1622.7	1618.0	1617.1	1629.9	1621.2	1606.6	1614.3
0:38:00	1608.6	1628.4	1623.4	1623.6	1634.2	1627.5	1612.2	1619.9
0:39:00	1614.6	1634.2	1629.0	1628.1	1639.9	1633.3	1618.2	1625.6

::5/7/2018

\\4788356132 - Processed Data

Page 5

FILE R39364

APPENDIX A

R-STUD LLC
 2-HR LOAD BEARING R-STUD WALL
 4788356132/R39364
 Test Date: 2018-05-04

FURNACE TEMPERATURES, °F

Time hr:min:sec	Furn. TC #6	Furn. TC #7	Furn. TC #8	Furn. TC #9	Furn. TC #10	Furn. TC #11	Furn. TC #12	AVERAGE
0:40:00	1617.8	1638.0	1632.4	1630.6	1645.7	1638.9	1621.8	1629.9
0:41:00	1622.3	1642.6	1636.9	1635.4	1650.2	1644.6	1625.0	1634.2
0:42:00	1628.4	1648.2	1642.6	1642.6	1656.1	1649.7	1632.0	1640.2
0:43:00	1633.3	1652.0	1646.4	1647.5	1660.6	1655.4	1635.8	1644.4
0:44:00	1638.9	1658.1	1652.2	1653.4	1666.2	1660.5	1643.0	1650.1
0:45:00	1643.2	1661.4	1656.7	1656.9	1669.8	1665.1	1649.5	1654.6
0:46:00	1647.5	1666.0	1660.5	1661.2	1673.2	1669.1	1652.2	1658.5
0:47:00	1652.4	1670.5	1665.0	1666.9	1678.1	1674.3	1658.3	1663.4
0:48:00	1655.6	1673.8	1668.6	1670.7	1682.1	1679.2	1660.8	1667.2
0:49:00	1661.7	1679.4	1674.5	1676.5	1687.3	1683.9	1668.9	1672.7
0:50:00	1665.0	1683.7	1677.9	1680.8	1690.9	1689.3	1673.2	1676.8
0:51:00	1670.0	1688.7	1683.7	1686.6	1695.6	1693.8	1679.5	1682.0
0:52:00	1673.2	1690.9	1686.9	1688.7	1699.0	1696.5	1682.1	1685.0
0:53:00	1677.9	1695.4	1691.6	1693.8	1702.6	1701.9	1688.2	1689.5
0:54:00	1681.2	1698.6	1693.9	1697.4	1706.4	1707.8	1690.5	1693.0
0:55:00	1686.2	1702.9	1696.3	1703.1	1709.8	1710.3	1696.1	1697.2
0:56:00	1689.6	1706.4	1699.9	1707.8	1713.2	1713.6	1700.8	1701.0
0:57:00	1692.9	1709.1	1704.4	1711.0	1715.5	1718.1	1704.4	1704.5
0:58:00	1697.2	1713.7	1710.5	1715.5	1720.4	1724.0	1707.6	1709.0
0:59:00	1702.9	1718.2	1716.1	1720.4	1724.9	1728.3	1713.6	1714.0
1:00:00	1706.5	1721.7	1719.5	1724.0	1727.1	1730.8	1715.9	1717.3
1:01:00	1710.3	1726.2	1724.4	1727.6	1731.9	1735.7	1720.4	1721.6
1:02:00	1713.6	1729.6	1728.9	1731.9	1735.9	1739.1	1725.6	1725.3
1:03:00	1715.7	1731.7	1729.9	1733.0	1737.0	1740.4	1727.8	1727.3
1:04:00	1720.2	1736.2	1734.6	1736.8	1742.5	1745.2	1730.7	1731.6
1:05:00	1722.7	1738.4	1737.1	1739.5	1744.9	1746.5	1734.3	1734.2
1:06:00	1726.3	1741.6	1739.3	1744.5	1748.5	1751.4	1738.2	1737.9
1:07:00	1730.1	1745.2	1742.7	1747.9	1750.6	1754.8	1742.0	1741.2
1:08:00	1732.3	1747.6	1743.8	1750.1	1753.0	1756.9	1743.4	1743.2
1:09:00	1735.9	1750.8	1744.9	1753.9	1757.5	1760.4	1747.9	1746.6
1:10:00	1737.0	1753.0	1741.1	1755.1	1758.7	1761.6	1750.5	1747.7
1:11:00	1744.5	1755.5	1740.9	1759.6	1763.6	1762.9	1753.0	1751.5
1:12:00	1743.4	1758.7	1739.8	1756.9	1767.9	1765.0	1753.2	1752.9
1:13:00	1744.7	1761.1	1743.3	1756.9	1771.3	1771.0	1756.8	1755.4
1:14:00	1750.5	1764.7	1747.8	1762.5	1772.6	1775.7	1760.4	1758.9
1:15:00	1753.7	1767.4	1751.2	1765.9	1776.2	1778.9	1763.8	1761.7
1:16:00	1757.3	1770.8	1755.5	1770.4	1778.7	1781.1	1768.6	1765.1
1:17:00	1758.6	1771.9	1756.6	1771.7	1780.0	1784.3	1768.6	1766.5
1:18:00	1761.1	1775.3	1760.0	1777.3	1784.8	1787.7	1770.8	1769.8
1:19:00	1763.2	1778.7	1763.4	1783.9	1785.9	1792.0	1774.0	1773.4

::5/7/2018

\\4788356132 - Processed Data

FILE R39364

APPENDIX A

R-STUD LLC
 2-HR LOAD BEARING R-STUD WALL
 4788356132/R39364
 Test Date: 2018-05-04

FURNACE TEMPERATURES, °F

Time hr:min:sec	Furn. TC #6	Furn. TC #7	Furn. TC #8	Furn. TC #9	Furn. TC #10	Furn. TC #11	Furn. TC #12	AVERAGE
1:20:00	1766.7	1779.8	1765.6	1787.5	1789.2	1795.5	1775.3	1775.9
1:21:00	1770.4	1784.3	1769.2	1792.0	1793.7	1799.2	1779.4	1780.2
1:22:00	1772.6	1785.4	1771.5	1794.2	1794.7	1802.8	1778.4	1781.8
1:23:00	1774.8	1787.5	1773.7	1796.4	1797.1	1805.0	1780.5	1784.5
1:24:00	1779.6	1792.4	1779.4	1800.9	1801.8	1806.3	1786.6	1789.1
1:25:00	1782.9	1794.6	1781.8	1795.1	1803.9	1807.3	1786.6	1790.6
1:26:00	1786.1	1795.6	1785.0	1795.1	1806.3	1807.3	1788.8	1792.5
1:27:00	1788.3	1799.1	1788.4	1797.3	1807.3	1810.8	1789.9	1795.1
1:28:00	1791.5	1801.8	1792.4	1798.5	1811.8	1811.8	1793.3	1797.9
1:29:00	1794.9	1803.0	1794.6	1801.8	1813.3	1813.1	1794.4	1800.2
1:30:00	1798.3	1807.5	1797.8	1806.1	1816.5	1815.3	1799.1	1803.9
1:31:00	1799.4	1807.7	1798.0	1806.3	1817.6	1817.4	1799.1	1805.0
1:32:00	1801.6	1810.2	1800.1	1809.5	1819.9	1819.6	1801.4	1807.3
1:33:00	1805.2	1812.7	1803.6	1813.1	1822.1	1821.9	1805.9	1810.5
1:34:00	1807.5	1816.0	1805.7	1815.3	1825.3	1824.1	1808.2	1813.0
1:35:00	1808.6	1818.1	1807.9	1816.5	1828.0	1824.1	1809.5	1814.9
1:36:00	1810.9	1820.5	1810.2	1818.7	1830.4	1826.2	1813.1	1817.5
1:37:00	1813.1	1821.6	1811.3	1819.9	1832.7	1826.2	1815.3	1819.0
1:38:00	1813.1	1821.6	1809.1	1818.9	1832.7	1826.1	1811.7	1818.5
1:39:00	1814.2	1825.0	1810.4	1820.1	1836.0	1826.1	1814.9	1820.8
1:40:00	1816.3	1828.4	1805.4	1822.5	1839.6	1823.2	1818.1	1822.2
1:41:00	1817.4	1826.1	1801.6	1824.8	1841.0	1824.6	1820.3	1822.9
1:42:00	1818.5	1824.8	1805.2	1825.9	1841.0	1829.5	1819.2	1823.6
1:43:00	1820.7	1825.9	1805.0	1827.0	1845.0	1832.7	1821.4	1825.2
1:44:00	1822.8	1828.0	1805.0	1829.1	1847.1	1836.3	1824.8	1827.2
1:45:00	1826.1	1825.7	1808.4	1832.5	1848.4	1835.2	1829.7	1829.7
1:46:00	1826.1	1824.6	1808.4	1832.5	1852.0	1834.0	1826.4	1829.8
1:47:00	1828.2	1827.1	1810.6	1834.9	1853.2	1832.9	1829.7	1831.7
1:48:00	1831.5	1829.5	1812.9	1838.3	1854.3	1835.4	1830.9	1834.0
1:49:00	1831.5	1831.6	1815.3	1841.5	1856.7	1835.4	1832.2	1835.8
1:50:00	1829.1	1833.8	1816.3	1836.3	1859.2	1838.7	1833.3	1836.7
1:51:00	1827.0	1836.0	1819.6	1828.2	1860.3	1844.6	1833.3	1837.2
1:52:00	1828.0	1838.1	1822.1	1827.1	1863.1	1845.5	1830.9	1838.7
1:53:00	1832.5	1843.0	1826.8	1831.6	1867.1	1851.6	1837.0	1843.0
1:54:00	1834.7	1844.1	1828.0	1832.7	1867.3	1855.4	1835.8	1844.2
1:55:00	1833.6	1844.1	1826.8	1831.6	1867.3	1857.7	1833.3	1843.9
1:56:00	1833.6	1824.8	1827.9	1831.6	1868.4	1857.7	1833.3	1842.8
1:57:00	1838.1	1818.5	1834.9	1836.0	1871.8	1859.9	1840.5	1846.3
1:58:00	1840.3	1819.6	1838.1	1839.9	1872.9	1866.9	1841.5	1848.8
1:59:00	1841.4	1819.6	1839.2	1841.2	1872.9	1868.0	1842.6	1849.6

FILE R39364

APPENDIX A

R-STUD LLC
 2-HR LOAD BEARING R-STUD WALL
 4788356132/R39364
 Test Date: 2018-05-04

FURNACE TEMPERATURES, °F

Time hr:min:sec	Furn. TC #6	Furn. TC #7	Furn. TC #8	Furn. TC #9	Furn. TC #10	Furn. TC #11	Furn. TC #12	AVERAGE
2:00:00	1841.4	1819.6	1839.2	1841.2	1872.9	1868.0	1841.4	1849.9
2:01:00	1842.4	1822.1	1842.8	1843.5	1876.5	1868.0	1842.4	1851.7
2:02:00	1843.5	1823.2	1843.9	1843.5	1876.5	1868.0	1843.5	1852.6
2:03:00	1844.6	1825.3	1845.0	1845.7	1878.6	1867.1	1846.2	1853.7
2:04:00	1846.9	1827.7	1846.0	1846.6	1879.7	1865.8	1851.1	1855.4
2:05:00	1846.9	1828.8	1847.1	1846.6	1879.7	1866.9	1849.1	1855.8
2:06:00	1848.0	1831.1	1848.4	1848.7	1878.6	1870.2	1850.4	1857.1
2:07:00	1846.9	1833.3	1849.5	1848.7	1881.3	1870.2	1849.3	1857.6
2:08:00	1849.1	1835.4	1850.5	1850.9	1882.4	1871.2	1850.4	1859.1
2:09:00	1849.1	1836.7	1851.6	1850.9	1883.7	1872.3	1851.4	1860.1
2:10:00	1849.1	1838.1	1852.9	1852.0	1884.9	1874.8	1851.4	1860.9
2:11:00	1850.2	1840.3	1854.0	1853.1	1886.2	1873.8	1850.0	1861.9
2:12:00	1851.3	1841.2	1852.9	1850.9	1887.3	1869.4	1850.0	1860.9
2:13:00	1851.3	1841.2	1849.5	1848.6	1888.5	1867.1	1848.7	1857.4
2:14:00	1852.5	1845.9	1852.9	1850.7	1891.4	1872.9	1845.1	1859.5
2:15:00	1854.0	1852.9	1855.6	1850.7	1892.7	1872.9	1841.7	1862.1
2:16:00	1849.1	1856.3	1856.7	1836.5	1894.1	1870.3	1836.9	1861.7

FILE R39364

APPENDIX B

R-STUD LLC
 2-HR LOAD BEARING R-STUD WALL
 4788356132/R39364
 Test Date: 2018-05-04

FURNACE PRESSURE, IN. H2O

Time	Time	Top Pressure	Center Pressure	Top Pressure
hr:min:sec				
0:00:00	0.0	0.147	0.147	0.145
0:01:00	1.0	-0.081	-0.118	-0.145
0:02:00	2.0	0.027	-0.013	-0.036
0:03:00	3.0	-0.051	-0.084	-0.104
0:04:00	4.0	0.007	-0.028	-0.057
0:05:00	5.0	-0.009	-0.044	-0.078
0:06:00	6.0	-0.026	-0.062	-0.094
0:07:00	7.0	-0.026	-0.061	-0.093
0:08:00	8.0	0.023	-0.013	-0.049
0:09:00	9.0	-0.025	-0.061	-0.099
0:10:00	10.0	-0.012	-0.036	-0.083
0:11:00	11.0	-0.014	-0.048	-0.085
0:12:00	12.0	-0.009	-0.046	-0.082
0:13:00	13.0	-0.009	-0.045	-0.080
0:14:00	14.0	0.009	-0.023	-0.063
0:15:00	15.0	0.002	-0.033	-0.071
0:16:00	16.0	-0.017	-0.052	-0.082
0:17:00	17.0	0.003	-0.032	-0.071
0:18:00	18.0	-0.022	-0.059	-0.097
0:19:00	19.0	0.019	-0.017	-0.053
0:20:00	20.0	-0.017	-0.053	-0.089
0:21:00	21.0	-0.031	-0.063	-0.102
0:22:00	22.0	-0.011	-0.046	-0.085
0:23:00	23.0	-0.027	-0.062	-0.098
0:24:00	24.0	0.003	-0.033	-0.071
0:25:00	25.0	-0.004	-0.040	-0.076
0:26:00	26.0	-0.014	-0.050	-0.088
0:27:00	27.0	0.000	-0.035	-0.074
0:28:00	28.0	-0.003	-0.037	-0.077
0:29:00	29.0	-0.003	-0.038	-0.077
0:30:00	30.0	0.009	-0.027	-0.068
0:31:00	31.0	0.003	-0.032	-0.072
0:32:00	32.0	-0.026	-0.060	-0.099
0:33:00	33.0	-0.013	-0.049	-0.084
0:34:00	34.0	-0.003	-0.039	-0.078
0:35:00	35.0	0.001	-0.034	-0.073

::5/7/2018

\\4788356132 - Processed Data

Page 1

FILE R39364

APPENDIX B

R-STUD LLC
 2-HR LOAD BEARING R-STUD WALL
 4788356132/R39364
 Test Date: 2018-05-04

FURNACE PRESSURE, IN. H2O

Time	Time	Top Pressure	Center Pressure	Top Pressure
hr:min:sec				
0:36:00	36.0	0.004	-0.031	-0.071
0:37:00	37.0	0.025	-0.011	-0.049
0:38:00	38.0	0.004	-0.033	-0.072
0:39:00	39.0	-0.008	-0.043	-0.080
0:40:00	40.0	-0.026	-0.063	-0.092
0:41:00	41.0	-0.003	-0.038	-0.078
0:42:00	42.0	0.016	-0.022	-0.056
0:43:00	43.0	0.001	-0.036	-0.073
0:44:00	44.0	0.040	0.006	-0.032
0:45:00	45.0	0.025	-0.012	-0.051
0:46:00	46.0	0.012	-0.022	-0.064
0:47:00	47.0	0.020	-0.018	-0.055
0:48:00	48.0	-0.002	-0.039	-0.077
0:49:00	49.0	-0.005	-0.042	-0.079
0:50:00	50.0	0.002	-0.034	-0.070
0:51:00	51.0	0.014	-0.023	-0.060
0:52:00	52.0	0.003	-0.032	-0.072
0:53:00	53.0	0.001	-0.033	-0.076
0:54:00	54.0	-0.010	-0.044	-0.087
0:55:00	55.0	-0.018	-0.054	-0.091
0:56:00	56.0	0.008	-0.029	-0.062
0:57:00	57.0	-0.027	-0.063	-0.100
0:58:00	58.0	-0.004	-0.039	-0.079
0:59:00	59.0	0.005	-0.033	-0.070
1:00:00	60.0	-0.017	-0.051	-0.089
1:01:00	61.0	-0.005	-0.041	-0.078
1:02:00	62.0	-0.015	-0.049	-0.091
1:03:00	63.0	-0.032	-0.065	-0.103
1:04:00	64.0	0.001	-0.034	-0.074
1:05:00	65.0	-0.027	-0.064	-0.102
1:06:00	66.0	0.008	-0.029	-0.067
1:07:00	67.0	0.003	-0.031	-0.072
1:08:00	68.0	-0.006	-0.041	-0.083
1:09:00	69.0	0.014	-0.022	-0.063
1:10:00	70.0	-0.010	-0.045	-0.084
1:11:00	71.0	-0.006	-0.040	-0.083

::5/7/2018

\\4788356132 - Processed Data

Page 2

FILE R39364

APPENDIX B

R-STUD LLC
 2-HR LOAD BEARING R-STUD WALL
 4788356132/R39364
 Test Date: 2018-05-04

FURNACE PRESSURE, IN. H2O

Time	Time	Top Pressure	Center Pressure	Top Pressure
hr:min:sec				
1:12:00	72.0	-0.003	-0.038	-0.081
1:13:00	73.0	-0.018	-0.054	-0.091
1:14:00	74.0	0.020	-0.016	-0.055
1:15:00	75.0	-0.007	-0.044	-0.080
1:16:00	76.0	-0.040	-0.074	-0.113
1:17:00	77.0	0.006	-0.028	-0.069
1:18:00	78.0	-0.001	-0.036	-0.077
1:19:00	79.0	0.009	-0.027	-0.067
1:20:00	80.0	-0.030	-0.065	-0.109
1:21:00	81.0	-0.012	-0.049	-0.086
1:22:00	82.0	-0.007	-0.041	-0.082
1:23:00	83.0	-0.008	-0.043	-0.085
1:24:00	84.0	0.004	-0.031	-0.073
1:25:00	85.0	-0.002	-0.039	-0.074
1:26:00	86.0	0.000	-0.035	-0.076
1:27:00	87.0	-0.003	-0.039	-0.077
1:28:00	88.0	-0.001	-0.034	-0.078
1:29:00	89.0	0.002	-0.033	-0.072
1:30:00	90.0	0.005	-0.030	-0.070
1:31:00	91.0	-0.021	-0.057	-0.093
1:32:00	92.0	0.024	-0.012	-0.049
1:33:00	93.0	0.003	-0.035	-0.069
1:34:00	94.0	-0.013	-0.049	-0.087
1:35:00	95.0	0.002	-0.035	-0.075
1:36:00	96.0	-0.007	-0.044	-0.083
1:37:00	97.0	-0.015	-0.052	-0.088
1:38:00	98.0	-0.016	-0.051	-0.090
1:39:00	99.0	-0.007	-0.044	-0.083
1:40:00	100.0	0.013	-0.024	-0.063
1:41:00	101.0	-0.002	-0.035	-0.076

FILE R39364

APPENDIX B

R-STUD LLC
 2-HR LOAD BEARING R-STUD WALL
 4788356132/R39364
 Test Date: 2018-05-04

FURNACE PRESSURE, IN. H2O

Time	Time	Top Pressure	Center Pressure	Top Pressure
hr:min:sec				
1:42:00	102.0	0.007	-0.030	-0.069
1:43:00	103.0	-0.005	-0.042	-0.079
1:44:00	104.0	0.025	-0.014	-0.050
1:45:00	105.0	-0.003	-0.038	-0.078
1:46:00	106.0	0.008	-0.028	-0.066
1:47:00	107.0	-0.010	-0.047	-0.084
1:48:00	108.0	-0.007	-0.040	-0.081
1:49:00	109.0	0.014	-0.023	-0.062
1:50:00	110.0	-0.003	-0.040	-0.078
1:51:00	111.0	0.001	-0.035	-0.076
1:52:00	112.0	0.014	-0.020	-0.062
1:53:00	113.0	0.002	-0.034	-0.072
1:54:00	114.0	-0.003	-0.038	-0.080
1:55:00	115.0	-0.014	-0.049	-0.089
1:56:00	116.0	-0.003	-0.039	-0.079
1:57:00	117.0	-0.004	-0.041	-0.078
1:58:00	118.0	-0.005	-0.041	-0.080
1:59:00	119.0	-0.008	-0.045	-0.084
2:00:00	120.0	0.007	-0.028	-0.070
2:01:00	121.0	-0.006	-0.042	-0.082
2:02:00	122.0	0.011	-0.025	-0.066
2:03:00	123.0	0.014	-0.022	-0.062
2:04:00	124.0	-0.040	-0.071	-0.113
2:05:00	125.0	0.003	-0.033	-0.072
2:06:00	126.0	-0.007	-0.044	-0.082
2:07:00	127.0	0.000	-0.036	-0.072
2:08:00	128.0	-0.001	-0.037	-0.076
2:09:00	129.0	0.001	-0.036	-0.076
2:10:00	130.0	0.008	-0.027	-0.068
2:11:00	131.0	0.000	-0.036	-0.078
2:12:00	132.0	0.007	-0.030	-0.070
2:13:00	133.0	-0.006	-0.042	-0.080
2:14:00	134.0	-0.017	-0.053	-0.092
2:15:00	135.0	-0.006	-0.042	-0.080
2:16:00	136.0	0.000	-0.040	-0.077

::5/7/2018

\\4788356132 - Processed Data

Page 4

FILE R39364

APPENDIX C

R-STUD LLC
 2-HR LOAD BEARING R-STUD WALL
 4788356132/R39364
 Test Date: 2018-05-04

STUD TEMPERATURES AND DEFLECTION, °F IN.

Time hr:min:sec	Stud TC 1	Stud TC 2	Stuc TC 3	MAXIMUM	AVERAGE	Sill Deflection Tag148	Sill Deflection Tag149
0:00:00	77.2	77.2	75.9	77.2	76.8	0.00	0.00
0:01:00	77.2	77.2	75.9	77.2	76.8	0.00	0.00
0:02:00	77.2	77.2	75.9	77.2	76.8	0.00	0.00
0:03:00	77.2	77.2	75.9	77.2	76.8	0.00	0.00
0:04:00	77.2	85.8	75.9	85.8	79.6	0.00	0.00
0:05:00	78.3	107.8	77.0	107.8	87.7	0.00	0.00
0:06:00	80.4	125.2	80.4	125.2	95.4	0.00	0.00
0:07:00	85.3	142.3	87.4	142.3	105.0	-0.01	0.00
0:08:00	93.6	153.1	100.4	153.1	115.7	-0.01	0.00
0:09:00	104.7	161.6	114.8	161.6	127.0	-0.01	-0.01
0:10:00	121.1	165.0	127.6	165.0	137.9	-0.01	-0.01
0:11:00	123.8	162.7	137.8	162.7	141.4	-0.01	-0.01
0:12:00	138.4	164.8	146.1	164.8	149.8	-0.02	-0.01
0:13:00	137.5	167.0	150.6	167.0	151.7	-0.02	-0.01
0:14:00	143.6	168.3	154.4	168.3	155.4	-0.02	-0.01
0:15:00	148.1	168.3	157.8	168.3	158.1	-0.02	-0.02
0:16:00	151.3	169.3	160.0	169.3	160.2	-0.02	-0.02
0:17:00	154.6	168.3	161.1	168.3	161.3	-0.02	-0.02
0:18:00	156.7	167.0	162.1	167.0	162.0	-0.02	-0.02
0:19:00	158.9	165.9	163.2	165.9	162.7	-0.02	-0.02
0:20:00	160.0	165.9	164.3	165.9	163.4	-0.02	-0.02
0:21:00	160.0	165.9	166.8	166.8	164.2	-0.02	-0.02
0:22:00	160.3	164.8	170.4	170.4	165.2	-0.02	-0.03
0:23:00	161.4	167.0	172.8	172.8	167.1	-0.03	-0.03
0:24:00	162.5	171.5	176.0	176.0	170.0	-0.03	-0.03
0:25:00	164.8	175.5	178.2	178.2	172.8	-0.03	-0.03
0:26:00	168.4	178.9	179.2	179.2	175.5	-0.03	-0.03
0:27:00	172.8	181.0	180.3	181.0	178.0	-0.03	-0.04
0:28:00	177.4	184.5	181.4	184.5	181.1	-0.03	-0.04
0:29:00	179.6	185.5	183.6	185.5	182.9	-0.03	-0.04
0:30:00	181.8	187.7	183.6	187.7	184.3	-0.04	-0.04
0:31:00	183.9	189.9	184.6	189.9	186.1	-0.04	-0.04
0:32:00	185.2	190.9	185.7	190.9	187.3	-0.04	-0.04
0:33:00	187.7	193.1	185.7	193.1	188.8	-0.04	-0.04
0:34:00	189.0	194.2	187.9	194.2	190.3	-0.04	-0.04
0:35:00	189.5	195.4	187.9	195.4	190.9	-0.04	-0.05
0:36:00	190.6	196.5	189.1	196.5	192.1	-0.04	-0.04
0:37:00	191.8	197.6	190.2	197.6	193.2	-0.04	-0.05
0:38:00	192.9	197.6	192.4	197.6	194.3	-0.04	-0.05
0:39:00	192.9	198.7	192.4	198.7	194.7	-0.05	-0.05
0:40:00	194.0	198.7	192.4	198.7	195.0	-0.05	-0.05
0:41:00	194.0	199.9	192.4	199.9	195.4	-0.05	-0.06
0:42:00	195.1	201.0	192.4	201.0	196.2	-0.05	-0.06

FILE R39364

APPENDIX C

R-STUD LLC
 2-HR LOAD BEARING R-STUD WALL
 4788356132/R39364
 Test Date: 2018-05-04

STUD TEMPERATURES AND DEFLECTION, °F IN.

Time hr:min:sec	Stud TC 1	Stud TC 2	Stuc TC 3	MAXIMUM	AVERAGE	Sill Deflection	Sill Deflection
						Tag148	Tag149
0:43:00	197.2	201.0	192.4	201.0	196.9	-0.05	-0.06
0:44:00	198.3	201.0	193.5	201.0	197.6	-0.05	-0.06
0:45:00	203.7	201.0	194.5	203.7	199.8	-0.06	-0.06
0:46:00	208.0	202.1	194.5	208.0	201.6	-0.06	-0.06
0:47:00	213.4	202.1	200.8	213.4	205.5	-0.06	-0.07
0:48:00	216.9	202.1	203.2	216.9	207.4	-0.06	-0.07
0:49:00	220.6	200.8	204.3	220.6	208.6	-0.06	-0.07
0:50:00	222.8	200.8	205.5	222.8	209.7	-0.06	-0.07
0:51:00	226.0	200.8	208.8	226.0	211.9	-0.06	-0.07
0:52:00	229.5	201.9	214.5	229.5	215.3	-0.07	-0.08
0:53:00	235.4	201.9	226.8	235.4	221.4	-0.07	-0.08
0:54:00	243.3	204.1	246.0	246.0	231.1	-0.08	-0.08
0:55:00	252.5	233.2	270.3	270.3	252.0	-0.08	-0.09
0:56:00	263.5	253.6	288.5	288.5	268.5	-0.09	-0.10
0:57:00	275.0	268.7	307.0	307.0	283.6	-0.09	-0.10
0:58:00	288.0	285.6	329.4	329.4	301.0	-0.10	-0.11
0:59:00	302.7	302.5	351.1	351.1	318.8	-0.11	-0.12
1:00:00	317.7	320.7	370.9	370.9	336.4	-0.12	-0.13
1:01:00	334.4	342.1	392.9	392.9	356.5	-0.14	-0.15
1:02:00	353.3	363.2	417.6	417.6	378.0	-0.15	-0.16
1:03:00	370.4	380.8	443.3	443.3	398.2	-0.16	-0.17
1:04:00	393.3	398.3	470.1	470.1	420.6	-0.17	-0.18
1:05:00	415.9	416.1	495.7	495.7	442.6	-0.17	-0.18
1:06:00	435.6	432.5	518.7	518.7	462.3	-0.17	-0.18
1:07:00	453.7	448.2	541.4	541.4	481.1	-0.17	-0.19
1:08:00	471.7	462.4	563.4	563.4	499.2	-0.18	-0.19
1:09:00	491.9	482.0	589.5	589.5	521.1	-0.18	-0.19
1:10:00	512.4	500.9	613.4	613.4	542.2	-0.18	-0.19
1:11:00	531.5	519.1	637.7	637.7	562.8	-0.18	-0.19
1:12:00	558.0	537.6	659.5	659.5	585.0	-0.19	-0.20
1:13:00	589.1	553.8	679.6	679.6	607.5	-0.19	-0.20
1:14:00	631.4	568.2	698.2	698.2	632.6	-0.19	-0.20
1:15:00	744.6	580.6	714.0	744.6	679.8	-0.19	-0.19
1:16:00	1233.1	593.8	730.2	1233.1	852.4	-0.18	-0.19
1:17:00	1470.2	601.5	742.5	1470.2	938.1	-0.18	-0.19
1:18:00	1523.1	612.5	754.5	1523.1	963.4	-0.18	-0.19
1:19:00	1523.5	622.4	768.0	1523.5	971.3	-0.18	-0.18
1:20:00	1514.3	629.6	780.3	1514.3	974.7	-0.18	-0.18
1:21:00	1517.0	640.8	793.4	1517.0	983.7	-0.18	-0.18
1:22:00	1523.8	648.7	806.7	1523.8	993.1	-0.17	-0.18
1:23:00	1525.3	658.2	820.0	1525.3	1001.2	-0.17	-0.17
1:24:00	1534.6	670.1	833.0	1534.6	1012.6	-0.17	-0.17
1:25:00	1517.2	680.2	845.4	1517.2	1014.3	-0.17	-0.17

FILE R39364

APPENDIX C

R-STUD LLC
 2-HR LOAD BEARING R-STUD WALL
 4788356132/R39364
 Test Date: 2018-05-04

STUD TEMPERATURES AND DEFLECTION, °F IN.

Time hr:min:sec	Stud TC 1	Stud TC 2	Stud TC 3	MAXIMUM	AVERAGE	Sill Deflection Tag148	Sill Deflection Tag149
1:26:00	1510.3	688.8	854.4	1510.3	1017.9	-0.17	-0.17
1:27:00	1463.5	701.2	864.3	1463.5	1009.7	-0.17	-0.17
1:28:00	1476.5	711.1	875.3	1476.5	1021.0	-0.17	-0.17
1:29:00	1488.9	719.8	892.6	1488.9	1033.8	-0.17	-0.17
1:30:00	1493.4	728.8	915.8	1493.4	1046.0	-0.17	-0.18
1:31:00	1499.4	736.7	950.0	1499.4	1062.0	-0.17	-0.17
1:32:00	1508.9	745.2	986.5	1508.9	1080.2	-0.17	-0.17
1:33:00	1508.4	752.9	1014.6	1508.4	1092.0	-0.17	-0.17
1:34:00	1516.5	756.5	1026.9	1516.5	1099.9	-0.17	-0.17
1:35:00	1521.0	763.2	1031.7	1521.0	1105.3	-0.17	-0.17
1:36:00	1532.5	773.1	1027.0	1532.5	1110.9	-0.17	-0.18
1:37:00	1551.2	788.2	1019.8	1551.2	1119.7	-0.17	-0.17
1:38:00	1562.0	807.6	1011.6	1562.0	1127.1	-0.17	-0.18
1:39:00	1458.5	837.5	1000.8	1458.5	1098.9	-0.17	-0.17
1:40:00	1704.2	901.4	990.0	1704.2	1198.5	-0.17	-0.17
1:41:00	2309.4	1035.3	985.3	2309.4	1443.3	-0.17	-0.17
1:42:00	2335.5	1204.0	981.9	2335.5	1507.1	-0.16	-0.17
1:43:00	2315.7	1251.0	979.7	2315.7	1515.4	-0.16	-0.17
1:44:00	2039.9	1409.9	977.5	2039.9	1475.8	-0.16	-0.17
1:45:00	1918.2	1576.4	978.6	1918.2	1491.1	-0.15	-0.17
1:46:00	1829.3	1553.4	979.7	1829.3	1454.1	-0.15	-0.17
1:47:00	1735.5	1602.9	981.9	1735.5	1440.1	-0.15	-0.17
1:48:00	1684.8	1562.4	986.5	1684.8	1411.2	-0.15	-0.17
1:49:00	1607.0	1501.3	993.7	1607.0	1367.4	-0.15	-0.17
1:50:00	1501.5	1473.4	1002.0	1501.5	1325.7	-0.15	-0.17
1:51:00	1501.5	1432.9	1011.2	1501.5	1315.2	-0.14	-0.17
1:52:00	1520.6	1341.9	1026.0	1520.6	1296.1	-0.14	-0.16
1:53:00	1474.7	1303.7	1050.4	1474.7	1276.3	-0.14	-0.15
1:54:00	1473.6	1316.3	1082.7	1473.6	1290.9	-0.13	-0.15
1:55:00	1492.9	1339.5	1134.7	1492.9	1322.4	-0.13	-0.14
1:56:00	1516.8	1359.7	1216.0	1516.8	1364.2	-0.13	-0.14
1:57:00	1529.2	1379.1	1311.8	1529.2	1406.7	-0.12	-0.13
1:58:00	1517.0	1391.4	1348.9	1517.0	1419.1	-0.12	-0.13
1:59:00	1535.7	1392.6	1349.6	1535.7	1426.0	-0.12	-0.12
2:00:00	1508.4	1396.6	1374.4	1508.4	1426.5	-0.11	-0.11
2:01:00	1491.4	1366.5	1438.2	1491.4	1432.0	-0.11	-0.11
2:02:00	1479.2	1366.5	1488.6	1488.6	1444.8	-0.10	-0.10
2:03:00	1469.7	1370.8	1469.1	1469.7	1436.5	-0.10	-0.09
2:04:00	1464.8	1371.6	1502.8	1502.8	1446.4	-0.10	-0.08
2:05:00	1415.8	1374.1	1514.5	1514.5	1434.8	-0.09	-0.08
2:06:00	1388.7	1374.1	1527.3	1527.3	1430.0	-0.09	-0.07
2:07:00	1445.0	1370.5	1533.7	1533.7	1449.7	-0.08	-0.06
2:08:00	1442.5	1358.4	1532.7	1532.7	1444.5	-0.07	-0.05

FILE R39364

APPENDIX C

R-STUD LLC
 2-HR LOAD BEARING R-STUD WALL
 4788356132/R39364
 Test Date: 2018-05-04

STUD TEMPERATURES AND DEFLECTION, °F IN.

Time hr:min:sec	Stud TC 1	Stud TC 2	Stuc TC 3	MAXIMUM	AVERAGE	Sill Deflection	Sill Deflection
						Tag148	Tag149
2:09:00	1439.2	1346.2	1528.9	1528.9	1438.1	-0.07	-0.03
2:10:00	1472.5	1339.2	1525.8	1525.8	1445.8	-0.06	-0.02
2:11:00	1433.3	1331.4	1534.8	1534.8	1433.2	-0.05	0.00
2:12:00	1422.9	1327.8	1540.6	1540.6	1430.4	-0.03	0.03
2:13:00	1411.3	1310.4	1551.9	1551.9	1424.5	-0.01	0.07
2:14:00	1343.7	1310.2	1566.5	1566.5	1406.8	0.02	0.13
2:15:00	1354.8	1311.4	1579.8	1579.8	1415.4	0.07	0.23
2:16:00	1407.4	1313.8	1588.5	1588.5	1436.5	0.16	0.39

FILE R39364

APPENDIX D

R-STUD LLC
 2-HR LOAD BEARING R-STUD WALL
 4788356132/R39364
 Test Date: 2018-05-04

UNEXPOSED SURFACE TEMPERATURES, °F

Time hr:min:sec	TC 1	TC 2	TC 3	TC 4	TC 5	TC 6
0:00:00	75.6	75.6	75.7	75.4	74.7	74.7
0:01:00	75.6	75.6	75.7	75.4	74.7	74.7
0:02:00	75.6	75.6	75.7	75.4	74.7	74.7
0:03:00	75.6	75.6	75.7	75.4	74.7	74.7
0:04:00	75.6	75.6	75.7	75.4	74.7	74.7
0:05:00	75.6	75.6	75.7	75.4	74.7	74.7
0:06:00	75.6	75.6	75.7	75.4	74.7	74.7
0:07:00	75.6	75.6	75.7	75.4	74.7	74.7
0:08:00	75.6	75.6	75.7	75.4	74.7	74.7
0:09:00	75.6	75.6	75.7	75.4	74.7	74.7
0:10:00	75.6	75.6	75.7	75.4	74.7	74.7
0:11:00	75.6	75.6	75.7	75.4	74.7	74.7
0:12:00	75.6	75.6	76.8	75.4	74.7	74.7
0:13:00	75.6	75.6	76.8	75.4	74.7	74.7
0:14:00	75.6	75.6	76.8	75.4	74.7	74.7
0:15:00	75.6	75.6	77.9	75.4	75.7	74.7
0:16:00	75.6	75.6	79.0	75.4	75.7	74.7
0:17:00	75.6	75.6	80.1	75.4	75.7	75.7
0:18:00	76.6	76.6	80.1	76.5	76.8	75.7
0:19:00	76.6	76.6	82.2	76.5	76.8	75.7
0:20:00	76.6	76.6	83.3	77.5	77.9	76.8
0:21:00	77.7	77.7	84.6	78.6	79.0	76.8
0:22:00	78.8	78.8	85.6	79.9	80.1	77.9
0:23:00	78.8	79.9	86.7	79.9	80.1	79.0
0:24:00	79.9	79.9	88.9	82.0	82.2	80.1
0:25:00	81.0	81.0	90.0	82.0	82.2	81.1
0:26:00	82.0	82.2	91.0	84.2	83.3	82.2
0:27:00	83.1	83.3	93.4	85.3	84.4	83.3
0:28:00	84.2	84.4	94.5	86.4	86.5	84.6
0:29:00	85.3	85.5	96.6	87.4	87.6	85.6
0:30:00	87.4	87.6	98.8	88.5	88.7	86.7
0:31:00	88.5	88.7	99.9	89.8	90.9	88.9
0:32:00	90.7	89.8	102.0	91.0	91.9	90.0
0:33:00	91.9	91.9	103.3	93.4	93.0	91.0
0:34:00	94.1	93.0	105.4	94.5	95.2	93.4

FILE R39364

APPENDIX D

R-STUD LLC
 2-HR LOAD BEARING R-STUD WALL
 4788356132/R39364
 Test Date: 2018-05-04

UNEXPOSED SURFACE TEMPERATURES, °F

Time hr:min:sec	TC 1	TC 2	TC 3	TC 4	TC 5	TC 6
0:35:00	96.3	95.2	106.9	96.6	97.3	95.5
0:36:00	98.4	97.3	109.0	97.7	99.5	97.9
0:37:00	100.6	99.5	110.1	98.8	100.6	100.0
0:38:00	102.9	101.7	112.6	101.3	102.7	102.2
0:39:00	105.3	104.0	113.7	102.4	104.9	104.4
0:40:00	108.7	106.3	115.9	104.5	107.1	106.5
0:41:00	110.8	108.7	117.0	106.7	109.2	109.8
0:42:00	113.2	111.4	119.1	107.8	111.6	111.9
0:43:00	116.4	113.7	120.2	109.9	113.7	114.1
0:44:00	118.8	115.9	121.3	112.1	114.8	116.4
0:45:00	120.9	118.0	123.6	113.2	117.0	118.8
0:46:00	123.1	120.2	124.7	115.3	118.0	119.8
0:47:00	124.2	122.5	125.8	116.4	120.2	122.0
0:48:00	126.5	124.7	127.0	118.6	121.3	124.2
0:49:00	128.7	125.8	129.2	119.7	122.4	125.2
0:50:00	129.7	127.9	130.3	121.8	124.7	127.4
0:51:00	131.9	129.0	131.4	122.9	125.8	128.5
0:52:00	133.0	130.1	132.4	125.1	125.8	129.6
0:53:00	134.1	132.4	132.4	126.1	126.9	130.6
0:54:00	136.2	133.5	133.5	127.2	127.9	131.9
0:55:00	137.3	134.6	134.6	128.3	129.0	133.0
0:56:00	137.3	135.7	135.7	129.4	129.0	134.1
0:57:00	138.4	135.7	135.7	130.5	130.1	135.1
0:58:00	138.4	136.8	136.8	131.7	130.1	135.1
0:59:00	138.4	136.8	136.8	132.8	131.2	135.1
1:00:00	138.4	137.8	136.8	133.9	131.2	136.2
1:01:00	138.4	137.8	137.8	133.9	132.4	136.2
1:02:00	138.4	137.8	137.8	135.0	133.5	136.2
1:03:00	138.4	137.8	137.8	135.0	134.6	135.1
1:04:00	138.4	136.8	138.9	135.0	136.8	135.1
1:05:00	138.4	136.8	138.9	135.0	137.8	135.1
1:06:00	137.3	136.8	140.0	135.0	140.0	135.1
1:07:00	137.3	136.8	140.0	135.0	142.3	135.1
1:08:00	137.3	135.7	141.1	135.0	143.8	135.1
1:09:00	137.3	135.7	142.2	135.0	145.0	135.1

::5/7/2018
 \\4788356132 - Processed Data

Page 2

FILE R39364

APPENDIX D

R-STUD LLC
 2-HR LOAD BEARING R-STUD WALL
 4788356132/R39364
 Test Date: 2018-05-04

UNEXPOSED SURFACE TEMPERATURES, °F

Time hr:min:sec	TC 1	TC 2	TC 3	TC 4	TC 5	TC 6
1:10:00	138.4	135.7	144.3	135.0	147.2	135.1
1:11:00	139.5	135.7	145.4	135.0	148.3	136.2
1:12:00	139.5	136.8	147.6	135.0	150.4	136.2
1:13:00	140.5	136.8	148.6	135.0	152.6	137.3
1:14:00	141.6	137.8	150.8	135.0	155.8	137.3
1:15:00	142.7	137.8	153.1	136.0	159.3	138.4
1:16:00	143.8	138.9	155.3	136.0	163.6	139.5
1:17:00	144.9	140.0	157.6	137.1	168.4	140.5
1:18:00	145.9	140.0	160.0	138.2	172.0	140.5
1:19:00	148.1	141.1	162.1	139.3	173.1	141.6
1:20:00	151.5	142.2	163.2	140.4	173.1	142.7
1:21:00	156.2	143.2	165.6	141.4	173.1	142.7
1:22:00	162.0	143.2	166.6	142.5	175.3	143.8
1:23:00	166.3	144.3	168.8	143.6	177.4	143.8
1:24:00	169.5	144.3	169.9	143.6	180.7	143.8
1:25:00	171.7	144.3	171.0	144.7	183.0	143.8
1:26:00	171.7	145.4	173.1	145.8	185.2	144.9
1:27:00	172.8	145.4	174.2	146.8	186.3	145.9
1:28:00	172.8	146.5	175.3	146.8	189.7	147.0
1:29:00	172.8	146.5	177.4	147.9	194.0	148.1
1:30:00	172.8	147.6	178.5	147.9	197.2	148.1
1:31:00	172.8	148.6	180.7	149.0	200.5	149.2
1:32:00	172.8	149.7	181.8	150.1	203.7	150.3
1:33:00	171.7	150.8	182.8	150.1	207.0	151.3
1:34:00	170.6	150.8	183.9	151.2	209.1	152.6
1:35:00	170.6	151.9	185.4	152.2	212.4	152.6
1:36:00	170.6	153.0	187.5	153.3	215.6	153.7
1:37:00	174.2	154.0	188.8	154.4	217.9	154.8
1:38:00	178.5	155.1	189.9	154.4	220.1	154.8
1:39:00	180.7	155.1	191.1	155.5	222.3	155.8
1:40:00	181.9	157.3	193.3	155.5	225.5	155.8
1:41:00	183.2	158.4	194.4	155.5	227.7	155.8
1:42:00	183.2	159.4	196.5	156.6	229.8	159.3
1:43:00	183.2	161.6	199.8	156.6	232.0	161.4
1:44:00	186.6	162.7	203.2	157.6	234.1	163.8

FILE R39364

APPENDIX D

R-STUD LLC
 2-HR LOAD BEARING R-STUD WALL
 4788356132/R39364
 Test Date: 2018-05-04

UNEXPOSED SURFACE TEMPERATURES, °F

Time hr:min:sec	TC 1	TC 2	TC 3	TC 4	TC 5	TC 6
1:45:00	190.9	164.8	206.4	157.6	238.5	164.8
1:46:00	195.3	165.9	209.8	157.6	245.5	165.9
1:47:00	199.9	167.0	213.1	157.6	264.4	165.9
1:48:00	203.2	167.0	217.4	158.7	294.8	167.0
1:49:00	207.5	167.0	222.3	158.7	339.8	167.0
1:50:00	210.7	165.9	226.8	158.7	413.8	167.0
1:51:00	214.0	164.8	232.5	158.7	479.5	168.1
1:52:00	216.3	163.8	236.8	158.7	545.5	169.3
1:53:00	218.5	163.8	241.3	158.7	628.9	171.5
1:54:00	220.6	164.8	246.0	158.7	744.3	174.9
1:55:00	221.7	167.2	250.7	159.8	825.8	177.3
1:56:00	222.8	169.5	255.4	162.1	884.3	179.4
1:57:00	225.0	171.7	260.1	163.2	935.1	181.6
1:58:00	226.2	174.0	265.3	164.3	982.9	185.0
1:59:00	227.3	177.4	270.7	165.4	1028.5	188.2
2:00:00	229.5	180.7	275.5	166.5	1070.6	190.4
2:01:00	231.8	183.9	281.1	167.5	1107.1	193.8
2:02:00	234.0	187.2	286.7	168.6	1134.3	196.0
2:03:00	237.2	189.5	293.7	169.7	1136.1	199.2
2:04:00	243.0	193.3	300.2	170.8	1114.9	202.6
2:05:00	257.0	195.4	307.2	172.9	1098.1	204.8
2:06:00	273.4	198.9	314.1	174.0	1089.5	208.0
2:07:00	307.2	201.0	322.3	175.1	1083.2	210.2
2:08:00	334.6	203.2	332.4	177.4	1078.7	213.4
2:09:00	406.0	205.3	343.4	179.6	1075.5	215.6
2:10:00	463.3	207.5	354.6	182.8	1074.4	217.9
2:11:00	522.7	210.7	368.8	187.2	1073.3	220.5
2:12:00	592.5	211.8	382.3	190.4	1074.4	222.6
2:13:00	680.7	214.0	398.1	192.7	1076.5	223.7
2:14:00	775.4	216.1	415.8	195.1	1080.0	224.8
2:15:00	850.3	218.3	435.7	197.2	1089.9	227.1
2:16:00	905.7	220.5	457.3	200.5	1105.3	228.2

FILE R39364

APPENDIX D

R-STUD LLC
 2-HR LOAD BEARING R-STUD WALL
 4788356132/R39364
 Test Date: 2018-05-04

UNEXPOSED SURFACE TEMPERATURES, °F

Time hr:min:sec	TC 7	TC 8	TC 9	TC 10	MAXIMUM	TC NO.	AVERAGE
0:00:00	74.7	74.1	75.0	74.8	75.7	TC 3	75.0
0:01:00	74.7	74.1	75.0	74.8	75.7	TC 3	75.0
0:02:00	74.7	74.1	75.0	74.8	75.7	TC 3	75.0
0:03:00	74.7	74.1	75.0	74.8	75.7	TC 3	75.0
0:04:00	74.7	74.1	75.0	74.8	75.7	TC 3	75.0
0:05:00	74.7	74.1	75.0	74.8	75.7	TC 3	75.0
0:06:00	74.7	74.1	75.0	74.8	75.7	TC 3	75.0
0:07:00	74.7	74.1	75.0	74.8	75.7	TC 3	75.0
0:08:00	74.7	74.1	75.0	74.8	75.7	TC 3	75.0
0:09:00	74.7	74.1	75.0	74.8	75.7	TC 3	75.0
0:10:00	74.7	74.1	75.0	74.8	75.7	TC 3	75.0
0:11:00	74.7	74.1	75.0	74.8	75.7	TC 3	75.0
0:12:00	74.7	74.1	75.0	74.8	76.8	TC 3	75.1
0:13:00	74.7	74.1	75.0	74.8	76.8	TC 3	75.1
0:14:00	74.7	74.1	75.0	74.8	76.8	TC 3	75.1
0:15:00	74.7	74.1	75.0	74.8	77.9	TC 3	75.3
0:16:00	75.7	75.2	75.0	74.8	79.0	TC 3	75.7
0:17:00	75.7	75.2	75.0	75.9	80.1	TC 3	76.0
0:18:00	76.8	75.2	76.3	75.9	80.1	TC 3	76.7
0:19:00	77.9	76.3	76.3	77.0	82.2	TC 3	77.2
0:20:00	79.0	77.4	77.4	78.1	83.3	TC 3	78.1
0:21:00	80.1	78.4	77.4	79.2	84.6	TC 3	78.9
0:22:00	81.1	78.4	78.4	80.2	85.6	TC 3	79.9
0:23:00	82.2	80.6	79.5	81.3	86.7	TC 3	80.8
0:24:00	83.3	81.7	80.6	82.4	88.9	TC 3	82.1
0:25:00	85.5	82.8	81.7	83.5	90.0	TC 3	83.1
0:26:00	86.5	83.8	82.9	84.6	91.0	TC 3	84.3
0:27:00	88.0	85.1	84.0	85.6	93.4	TC 3	85.6
0:28:00	89.1	87.3	85.1	86.7	94.5	TC 3	86.9
0:29:00	91.2	89.4	86.2	87.8	96.6	TC 3	88.3
0:30:00	93.4	91.6	87.3	90.0	98.8	TC 3	90.0
0:31:00	94.5	93.7	88.3	91.0	99.9	TC 3	91.4
0:32:00	95.5	95.9	90.5	92.3	102.0	TC 3	93.0
0:33:00	97.7	98.1	91.6	94.5	103.3	TC 3	94.6
0:34:00	99.9	101.3	93.9	95.5	105.4	TC 3	96.6

::5/7/2018

\\4788356132 - Processed Data

Page 5

FILE R39364

APPENDIX D

R-STUD LLC
 2-HR LOAD BEARING R-STUD WALL
 4788356132/R39364
 Test Date: 2018-05-04

UNEXPOSED SURFACE TEMPERATURES, °F

Time hr:min:sec	TC 7	TC 8	TC 9	TC 10	MAXIMUM	TC NO.	AVERAGE
0:35:00	101.3	103.5	96.3	97.7	106.9	TC 3	98.7
0:36:00	103.6	106.7	98.4	99.9	109.0	TC 3	100.9
0:37:00	105.8	109.0	99.5	101.1	110.1	TC 3	102.5
0:38:00	106.9	111.6	101.8	103.5	112.6	TC 3	104.7
0:39:00	109.0	113.9	104.0	104.7	113.9	TC 8	106.6
0:40:00	111.2	117.5	106.2	106.9	117.5	TC 8	109.1
0:41:00	112.3	119.7	108.5	108.0	119.7	TC 8	111.1
0:42:00	114.8	122.0	110.8	110.1	122.0	TC 8	113.3
0:43:00	115.9	124.2	113.0	112.5	124.2	TC 8	115.4
0:44:00	118.0	126.3	115.2	113.5	126.3	TC 8	117.2
0:45:00	119.3	128.5	117.3	115.7	128.5	TC 8	119.2
0:46:00	121.5	130.8	119.5	118.0	130.8	TC 8	121.1
0:47:00	122.5	131.9	121.8	119.1	131.9	TC 8	122.6
0:48:00	124.7	134.1	124.0	121.3	134.1	TC 8	124.6
0:49:00	125.8	135.1	125.2	122.4	135.1	TC 8	125.9
0:50:00	126.9	137.3	126.3	123.6	137.3	TC 8	127.6
0:51:00	127.9	138.4	128.5	125.8	138.4	TC 8	129.0
0:52:00	129.0	139.5	129.6	126.9	139.5	TC 8	130.1
0:53:00	130.1	140.5	130.6	127.9	140.5	TC 8	131.2
0:54:00	131.2	141.6	131.7	130.1	141.6	TC 8	132.5
0:55:00	132.3	141.6	132.8	131.2	141.6	TC 8	133.5
0:56:00	133.3	141.6	133.9	132.3	141.6	TC 8	134.2
0:57:00	134.4	141.6	135.0	132.3	141.6	TC 8	134.9
0:58:00	134.4	141.6	135.0	133.3	141.6	TC 8	135.3
0:59:00	135.5	141.6	136.2	134.6	141.6	TC 8	135.9
1:00:00	135.5	141.6	136.2	134.6	141.6	TC 8	136.2
1:01:00	136.6	140.5	136.2	135.7	140.5	TC 8	136.6
1:02:00	136.6	140.5	136.2	135.7	140.5	TC 8	136.8
1:03:00	136.6	140.5	135.1	135.7	140.5	TC 8	136.7
1:04:00	136.6	141.6	135.1	135.7	141.6	TC 8	137.0
1:05:00	136.6	141.6	135.1	135.7	141.6	TC 8	137.1
1:06:00	136.6	142.7	135.1	135.7	142.7	TC 8	137.4
1:07:00	136.6	143.8	135.1	135.7	143.8	TC 8	137.8
1:08:00	136.6	144.9	135.1	135.7	144.9	TC 8	138.0
1:09:00	136.6	145.9	135.1	135.7	145.9	TC 8	138.4

::5/7/2018

\\4788356132 - Processed Data

Page 6

FILE R39364

APPENDIX D

R-STUD LLC
 2-HR LOAD BEARING R-STUD WALL
 4788356132/R39364
 Test Date: 2018-05-04

UNEXPOSED SURFACE TEMPERATURES, °F

Time hr:min:sec	TC 7	TC 8	TC 9	TC 10	MAXIMUM	TC NO.	AVERAGE
1:10:00	136.6	147.0	135.1	135.7	147.2	TC 5	139.0
1:11:00	136.6	148.1	135.1	135.7	148.3	TC 5	139.6
1:12:00	136.6	152.1	135.1	136.8	152.1	TC 8	140.6
1:13:00	137.8	160.0	136.2	136.8	160.0	TC 8	142.2
1:14:00	137.8	165.0	136.2	138.0	165.0	TC 8	143.5
1:15:00	138.9	168.3	137.3	138.0	168.3	TC 8	145.0
1:16:00	140.0	169.3	137.3	140.5	169.3	TC 8	146.4
1:17:00	141.1	170.4	138.6	141.6	170.4	TC 8	148.0
1:18:00	142.2	169.3	139.6	142.7	172.0	TC 5	149.1
1:19:00	143.2	169.3	139.6	144.9	173.1	TC 5	150.2
1:20:00	145.4	169.3	140.7	145.9	173.1	TC 5	151.4
1:21:00	146.5	169.3	141.8	147.0	173.1	TC 5	152.7
1:22:00	147.6	168.3	141.8	148.1	175.3	TC 5	153.9
1:23:00	147.6	168.3	142.9	149.2	177.4	TC 5	155.2
1:24:00	148.6	169.3	142.9	149.2	180.7	TC 5	156.2
1:25:00	149.7	170.4	142.9	150.3	183.0	TC 5	157.2
1:26:00	150.8	173.8	144.0	151.3	185.2	TC 5	158.6
1:27:00	150.8	177.3	144.0	152.4	186.3	TC 5	159.6
1:28:00	151.9	178.3	145.0	152.4	189.7	TC 5	160.6
1:29:00	153.0	179.4	146.1	153.5	194.0	TC 5	161.9
1:30:00	153.0	180.5	149.4	154.6	197.2	TC 5	163.0
1:31:00	154.0	180.5	154.6	154.6	200.5	TC 5	164.4
1:32:00	155.1	180.5	160.0	155.7	203.7	TC 5	166.0
1:33:00	155.1	181.6	164.5	155.7	207.0	TC 5	167.1
1:34:00	156.2	182.8	166.8	156.7	209.1	TC 5	168.1
1:35:00	156.2	187.2	166.8	156.7	212.4	TC 5	169.2
1:36:00	156.2	191.8	167.9	156.7	215.6	TC 5	170.6
1:37:00	157.3	196.3	167.9	157.8	217.9	TC 5	172.3
1:38:00	157.3	200.8	166.8	157.8	220.1	TC 5	173.6
1:39:00	157.3	204.3	166.8	157.8	222.3	TC 5	174.7
1:40:00	157.3	208.8	166.8	158.9	225.5	TC 5	176.1
1:41:00	157.3	212.2	166.8	158.9	227.7	TC 5	177.0
1:42:00	157.3	214.3	167.9	158.9	229.8	TC 5	178.3
1:43:00	157.3	217.8	169.0	158.9	232.0	TC 5	179.7
1:44:00	157.3	219.9	170.1	158.9	234.1	TC 5	181.4

::5/7/2018

\\4788356132 - Processed Data

Page 7

FILE R39364

APPENDIX D

R-STUD LLC
 2-HR LOAD BEARING R-STUD WALL
 4788356132/R39364
 Test Date: 2018-05-04

UNEXPOSED SURFACE TEMPERATURES, °F

Time hr:min:sec	TC 7	TC 8	TC 9	TC 10	MAXIMUM	TC NO.	AVERAGE
1:45:00	158.4	222.1	170.1	158.9	238.5	TC 5	183.3
1:46:00	158.4	224.4	170.1	158.9	245.5	TC 5	185.2
1:47:00	158.4	225.5	170.1	160.0	264.4	TC 5	188.2
1:48:00	159.4	227.8	172.2	161.1	294.8	TC 5	192.9
1:49:00	159.4	228.9	174.6	162.1	339.8	TC 5	198.7
1:50:00	159.4	231.1	175.8	163.2	413.8	TC 5	207.2
1:51:00	161.6	233.2	178.0	164.3	479.5	TC 5	215.5
1:52:00	161.6	237.6	179.1	165.4	545.5	TC 5	223.4
1:53:00	162.7	242.1	179.1	166.5	628.9	TC 5	233.3
1:54:00	162.7	250.3	181.2	166.5	744.3	TC 5	247.0
1:55:00	163.8	262.0	185.7	167.5	825.8	TC 5	258.2
1:56:00	163.8	274.5	189.0	167.5	884.3	TC 5	266.8
1:57:00	164.8	305.6	193.6	169.7	935.1	TC 5	277.0
1:58:00	164.8	323.8	198.0	170.8	982.9	TC 5	285.5
1:59:00	164.8	363.0	201.6	172.9	1028.5	TC 5	296.0
2:00:00	165.9	421.9	205.0	175.3	1070.6	TC 5	308.1
2:01:00	165.9	470.3	208.2	180.0	1107.1	TC 5	319.0
2:02:00	167.0	520.0	211.6	185.7	1134.3	TC 5	329.1
2:03:00	168.1	577.9	214.0	189.3	1136.1	TC 5	337.5
2:04:00	169.2	651.4	216.1	192.7	1114.9	TC 5	345.4
2:05:00	170.2	734.7	218.3	196.2	1098.1	TC 5	355.5
2:06:00	172.4	809.8	220.5	199.4	1089.5	TC 5	366.0
2:07:00	178.3	865.0	222.6	202.8	1083.2	TC 5	376.8
2:08:00	182.8	910.2	224.8	206.4	1078.7	TC 5	386.4
2:09:00	186.3	949.6	227.3	208.8	1075.5	TC 5	399.7
2:10:00	188.6	983.1	229.5	212.2	1074.4	TC 5	411.4
2:11:00	191.8	1014.3	233.8	215.4	1073.3	TC 5	423.8
2:12:00	195.4	1046.8	240.4	217.6	1074.4	TC 5	437.4
2:13:00	197.6	1086.4	258.4	219.7	1086.4	TC 5	454.8
2:14:00	199.8	1089.7	290.7	223.2	1089.7	TC 5	471.0
2:15:00	203.0	1043.1	409.6	225.5	1089.9	TC 5	490.0
2:16:00	206.4	1012.8	584.6	228.7	1105.3	TC 5	515.0

::5/7/2018

\\4788356132 - Processed Data

Page 8

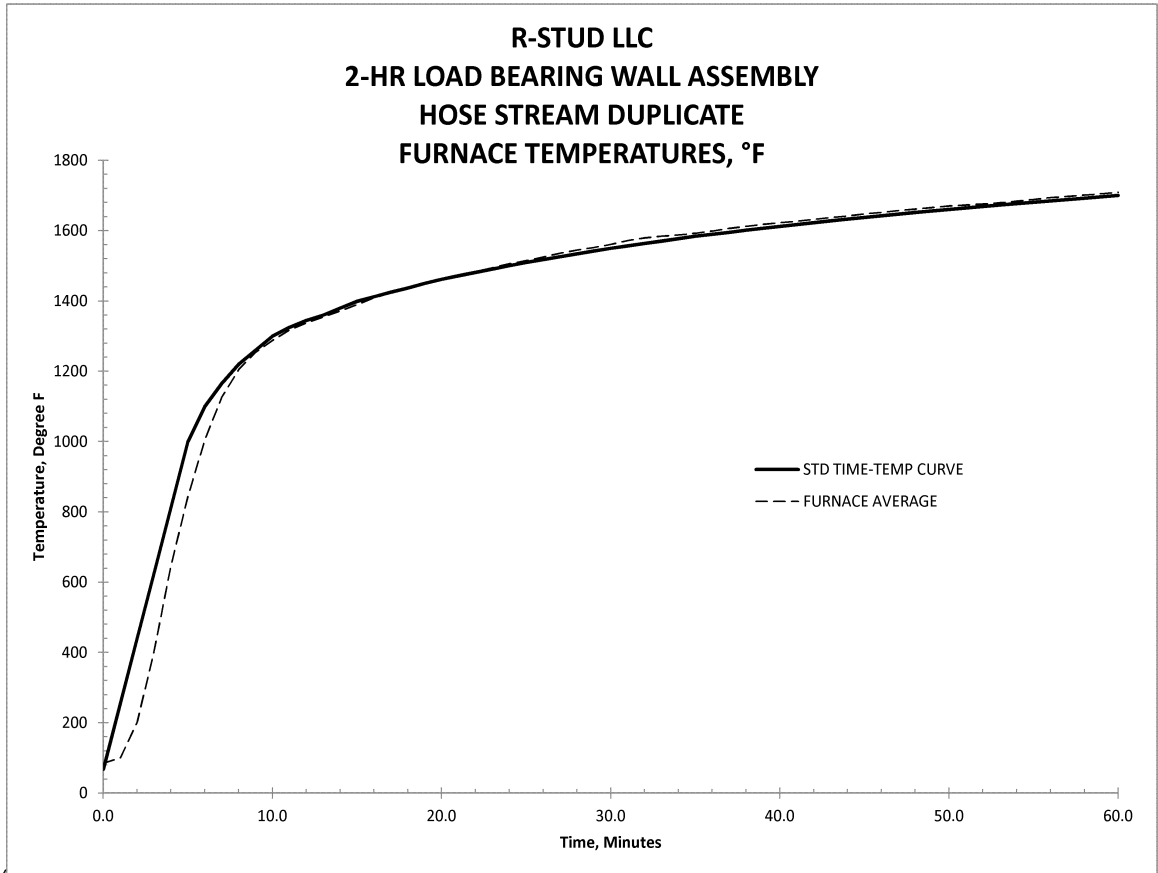

4788356132/4788356132

Test Date: 2018-05-04

\\4788356132 - Processed Data (HS Duplicate)

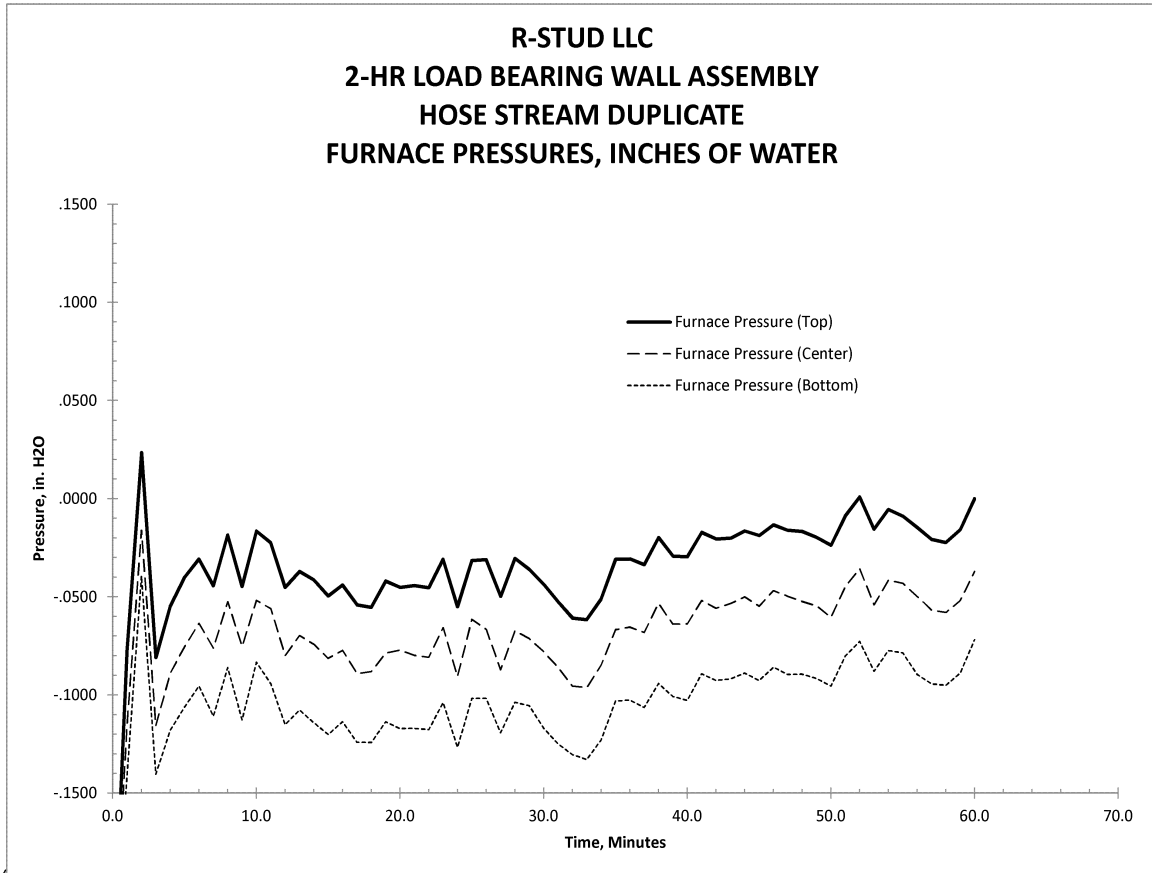

4788356132/4788356132

Test Date: 2018-05-04

\\4788356132 - Processed Data (HS Duplicate)

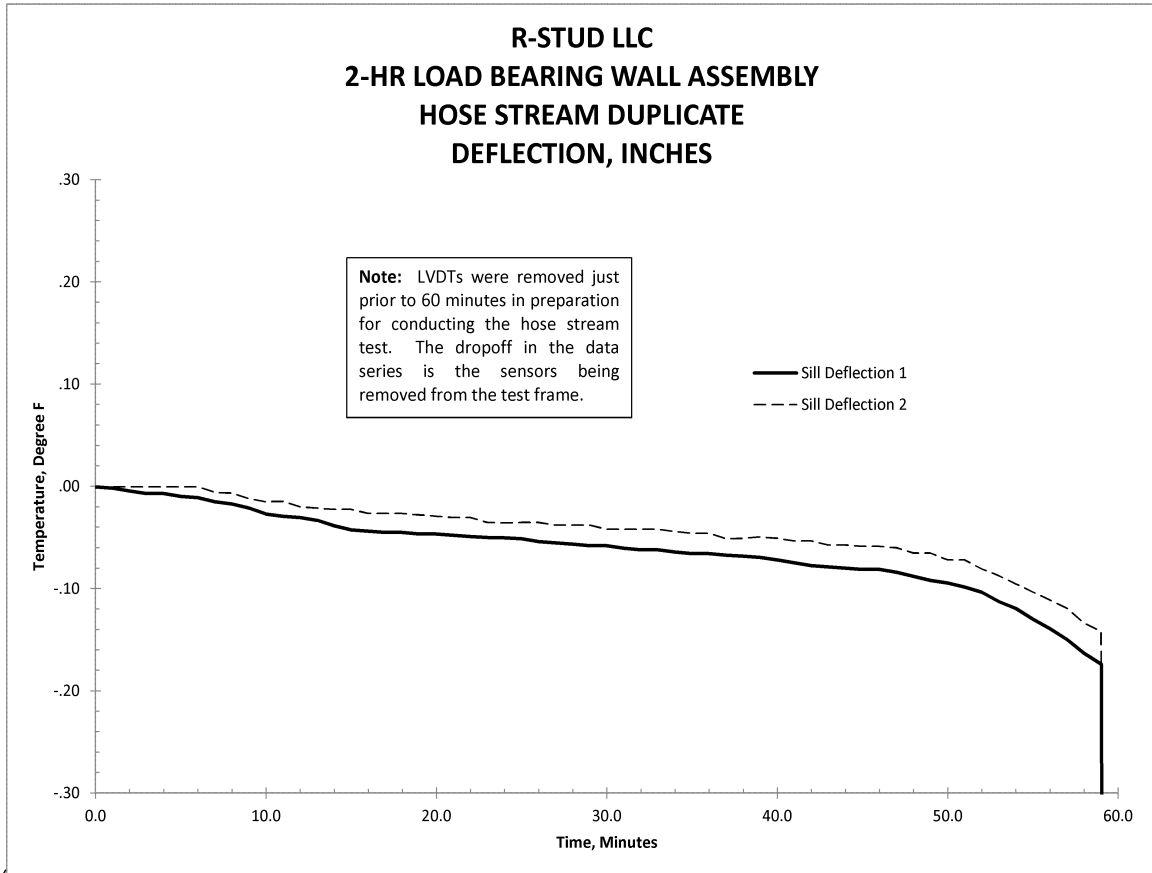

4788356132/4788356132

Test Date: 2018-05-04

\\4788356132 - Processed Data (HS Duplicate)

FILE R39364

APPENDIX A

R-STUD LLC
 2-HR LOAD BEARING WALL ASSEMBLY
 4788356132/R39364
 Test Date: 2018-05-04

FURNACE TEMPERATURES, °F

hr:min:sec Format	STD TIME-	Furn. TC #1 #	Furn. TC #2 #	Furn. TC #3 #	Furn. TC #4 #	Furn. TC #5 #	Furn. TC #6 #
	TEMP CURVE						
0:00:00	68.0	88.3	89.1	88.9	85.6	83.7	86.7
0:01:00	254.4	111.7	107.6	108.9	107.1	97.5	102.9
0:02:00	440.8	223.2	219.0	240.4	219.9	197.4	209.3
0:03:00	627.2	419.2	438.4	518.0	429.3	408.4	431.8
0:04:00	813.6	659.5	691.2	788.9	680.4	669.7	696.0
0:05:00	1000.0	846.7	871.5	960.4	881.1	859.6	890.2
0:06:00	1100.0	980.8	1008.7	1087.9	1026.1	1019.7	1039.3
0:07:00	1165.0	1095.6	1110.7	1175.5	1132.5	1145.5	1146.0
0:08:00	1220.0	1179.5	1181.8	1233.7	1207.4	1221.6	1214.4
0:09:00	1260.0	1236.4	1233.7	1269.3	1260.1	1268.4	1257.4
0:10:00	1300.0	1276.0	1274.4	1295.6	1294.0	1297.0	1288.9
0:11:00	1325.0	1309.3	1309.5	1321.2	1324.4	1322.2	1314.9
0:12:00	1345.0	1333.2	1330.2	1341.0	1345.8	1336.1	1335.4
0:13:00	1360.0	1354.1	1349.1	1359.3	1365.8	1345.8	1351.9
0:14:00	1380.0	1373.4	1368.1	1376.1	1385.2	1358.1	1368.5
0:15:00	1399.0	1391.9	1385.2	1393.5	1403.8	1376.2	1385.4
0:16:00	1412.0	1406.1	1405.9	1413.9	1424.1	1400.9	1404.3
0:17:00	1425.0	1420.0	1423.4	1428.1	1438.3	1422.9	1417.8
0:18:00	1437.0	1434.0	1436.5	1440.7	1453.5	1440.5	1430.1
0:19:00	1450.0	1445.7	1447.9	1451.8	1464.4	1455.6	1441.6
0:20:00	1462.0	1457.1	1461.4	1467.7	1476.7	1471.1	1456.7
0:21:00	1471.6	1466.6	1470.7	1480.5	1487.3	1484.4	1470.7
0:22:00	1481.2	1478.7	1479.7	1488.6	1497.0	1495.2	1479.7
0:23:00	1490.8	1488.4	1493.4	1499.5	1507.1	1507.6	1490.7
0:24:00	1500.4	1499.4	1504.4	1513.0	1517.5	1519.5	1503.9
0:25:00	1510.0	1508.2	1510.0	1520.4	1526.9	1529.1	1513.9
0:26:00	1518.0	1517.0	1519.9	1531.6	1537.2	1537.0	1527.3
0:27:00	1526.0	1525.6	1532.8	1543.3	1546.0	1545.8	1540.2
0:28:00	1534.0	1533.9	1542.7	1551.9	1552.8	1553.0	1550.8
0:29:00	1542.0	1539.5	1550.8	1560.9	1559.5	1560.0	1559.1
0:30:00	1550.0	1546.9	1559.3	1570.3	1566.3	1566.0	1572.4
0:31:00	1556.8	1553.9	1572.3	1575.1	1573.7	1577.3	1574.6
0:32:00	1563.6	1559.5	1580.4	1578.4	1578.4	1585.8	1575.9
0:33:00	1570.4	1565.4	1585.9	1580.5	1583.2	1590.4	1576.9
0:34:00	1577.2	1572.4	1589.2	1582.7	1589.5	1593.7	1578.0
0:35:00	1584.0	1578.0	1593.7	1587.6	1596.7	1598.0	1581.4
0:36:00	1589.8	1585.2	1600.5	1594.2	1603.6	1604.5	1588.6
0:37:00	1595.6	1592.6	1609.0	1603.0	1610.8	1612.4	1596.9
0:38:00	1601.4	1598.5	1614.9	1610.1	1615.8	1620.7	1603.8
0:39:00	1607.2	1605.2	1620.5	1614.4	1621.8	1626.3	1609.3
0:40:00	1613.0	1610.8	1625.0	1618.9	1628.2	1630.9	1611.7
0:41:00	1618.0	1616.7	1629.7	1623.4	1634.0	1635.3	1616.0
0:42:00	1623.0	1622.8	1635.3	1629.3	1639.6	1640.8	1620.7
0:43:00	1628.0	1627.9	1640.5	1634.2	1644.3	1645.9	1625.5

FILE R39364

APPENDIX A

R-STUD LLC
 2-HR LOAD BEARING WALL ASSEMBLY
 4788356132/R39364
 Test Date: 2018-05-04

FURNACE TEMPERATURES, °F

STD TIME-							
hr:min:sec	TEMP CURVE	Furn. TC #1	Furn. TC #2	Furn. TC #3	Furn. TC #4	Furn. TC #5	Furn. TC #6
0:44:00	1633.0	1632.6	1643.7	1639.0	1650.0	1651.5	1630.2
0:45:00	1638.0	1638.3	1649.7	1645.0	1655.8	1657.8	1636.9
0:46:00	1642.6	1642.8	1654.2	1649.3	1660.3	1661.5	1641.4
0:47:00	1647.2	1647.5	1660.3	1655.2	1665.1	1665.9	1646.1
0:48:00	1651.8	1652.0	1663.7	1659.0	1669.8	1670.5	1650.7
0:49:00	1656.4	1656.5	1668.2	1664.4	1674.5	1675.2	1655.1
0:50:00	1661.0	1660.3	1673.8	1668.7	1677.9	1678.6	1659.4
0:51:00	1665.0	1662.8	1676.1	1673.6	1680.1	1677.0	1663.0
0:52:00	1669.0	1667.1	1679.5	1677.2	1683.5	1680.3	1666.2
0:53:00	1673.0	1671.6	1684.0	1681.7	1688.0	1683.7	1669.5
0:54:00	1677.0	1675.0	1688.5	1686.4	1692.5	1689.6	1674.1
0:55:00	1681.0	1679.7	1694.3	1690.9	1697.0	1695.4	1678.5
0:56:00	1684.8	1684.4	1699.2	1695.2	1701.5	1699.9	1684.4
0:57:00	1688.6	1688.2	1702.4	1697.4	1704.9	1703.5	1687.6
0:58:00	1692.4	1693.0	1705.8	1702.0	1708.2	1707.1	1692.0
0:59:00	1696.2	1696.6	1710.3	1706.5	1711.6	1712.5	1695.4
1:00:00	1700.0	1700.4	1713.6	1710.1	1716.1	1716.3	1699.9

FILE R39364

APPENDIX A

R-STUD LLC
 2-HR LOAD BEARING WALL ASSEMBLY
 4788356132/R39364
 Test Date: 2018-05-04

FURNACE TEMPERATURES, °F

hr:min:sec	Furn. TC #7	Furn. TC #8	Furn. TC #9	Furn. TC #10	Furn. TC #11	Furn. TC #12	FURNACE AVERAGE
Format	#	#	#	#	#	#	
0:00:00	80.8	83.5	82.9	79.5	91.0	82.8	85
0:01:00	91.0	97.2	95.7	92.3	100.8	90.5	100
0:02:00	181.2	192.0	192.9	197.8	182.1	165.2	202
0:03:00	364.5	387.0	390.0	394.3	354.4	316.8	404
0:04:00	600.3	638.1	637.7	633.4	559.0	514.6	647
0:05:00	810.5	849.6	844.0	856.9	752.7	711.7	845
0:06:00	990.3	1028.7	1011.6	1045.6	943.0	887.4	1006
0:07:00	1121.5	1158.8	1133.2	1182.9	1087.0	1023.1	1126
0:08:00	1201.5	1237.3	1213.5	1274.5	1169.2	1116.7	1204
0:09:00	1252.9	1282.5	1267.7	1328.4	1209.2	1179.3	1254
0:10:00	1288.2	1309.6	1305.5	1363.5	1236.7	1224.7	1288
0:11:00	1319.7	1337.4	1338.1	1388.5	1262.7	1261.8	1317
0:12:00	1341.7	1354.8	1355.7	1404.0	1279.4	1288.0	1337
0:13:00	1361.7	1369.2	1370.8	1420.3	1295.4	1310.4	1354
0:14:00	1378.9	1384.5	1388.5	1436.2	1313.4	1330.7	1372
0:15:00	1397.8	1401.4	1404.5	1454.7	1332.1	1350.3	1390
0:16:00	1416.9	1418.4	1421.8	1469.1	1350.7	1369.9	1409
0:17:00	1432.2	1431.9	1435.1	1478.3	1365.4	1387.0	1423
0:18:00	1445.7	1443.4	1446.8	1489.6	1377.9	1400.2	1437
0:19:00	1458.3	1454.4	1458.0	1502.8	1392.1	1411.3	1449
0:20:00	1471.8	1466.8	1471.8	1512.3	1404.5	1424.7	1462
0:21:00	1484.1	1479.6	1482.1	1521.5	1416.9	1436.2	1473
0:22:00	1494.1	1489.3	1491.1	1531.2	1427.5	1448.4	1483
0:23:00	1504.2	1499.5	1503.5	1540.2	1438.5	1461.9	1495
0:24:00	1514.5	1510.2	1513.8	1549.0	1449.3	1474.3	1506
0:25:00	1522.9	1519.9	1522.9	1557.0	1458.9	1484.8	1515
0:26:00	1533.6	1529.1	1537.5	1565.2	1468.8	1498.1	1525
0:27:00	1543.3	1537.5	1550.5	1574.1	1481.0	1510.0	1536
0:28:00	1552.8	1545.8	1561.5	1580.4	1490.2	1519.2	1545
0:29:00	1559.7	1552.6	1570.1	1588.5	1497.9	1527.3	1552
0:30:00	1567.4	1560.4	1583.2	1594.4	1507.3	1535.9	1561
0:31:00	1577.1	1574.1	1588.1	1603.2	1530.1	1563.8	1572
0:32:00	1584.0	1582.9	1591.3	1605.7	1549.2	1583.2	1580
0:33:00	1589.5	1588.3	1596.0	1611.5	1558.6	1584.3	1584
0:34:00	1594.4	1591.9	1599.4	1616.5	1563.4	1584.3	1588
0:35:00	1599.1	1596.6	1603.9	1623.4	1569.0	1583.2	1593
0:36:00	1605.7	1604.5	1611.0	1629.1	1576.0	1585.4	1599
0:37:00	1611.5	1612.8	1618.2	1635.1	1583.4	1591.2	1606
0:38:00	1617.6	1621.2	1623.0	1636.3	1591.7	1597.1	1613
0:39:00	1624.8	1625.5	1625.2	1642.5	1598.5	1604.7	1618
0:40:00	1630.2	1628.8	1623.0	1647.3	1605.4	1611.5	1623
0:41:00	1635.1	1632.2	1623.0	1651.8	1609.9	1617.1	1627
0:42:00	1641.2	1636.9	1626.4	1656.9	1615.6	1621.9	1632
0:43:00	1645.9	1641.6	1630.9	1661.7	1620.5	1627.5	1637

FILE R39364

APPENDIX A

R-STUD LLC
 2-HR LOAD BEARING WALL ASSEMBLY
 4788356132/R39364
 Test Date: 2018-05-04

FURNACE TEMPERATURES, °F

hr:min:sec	Furn. TC #7	Furn. TC #8	Furn. TC #9	Furn. TC #10	Furn. TC #11	Furn. TC #12	FURNACE AVERAGE
0:44:00	1651.5	1645.9	1634.2	1666.8	1626.3	1631.1	1642
0:45:00	1657.8	1650.7	1640.1	1672.9	1630.8	1636.9	1648
0:46:00	1662.3	1655.6	1644.8	1675.2	1636.2	1641.6	1652
0:47:00	1667.7	1660.5	1649.3	1678.8	1641.2	1646.4	1657
0:48:00	1672.3	1664.1	1654.0	1683.3	1644.6	1651.1	1661
0:49:00	1677.0	1667.3	1658.5	1688.0	1649.1	1656.5	1666
0:50:00	1681.5	1671.6	1661.7	1694.1	1652.5	1661.5	1670
0:51:00	1683.7	1668.2	1666.2	1697.5	1659.4	1667.3	1673
0:52:00	1685.8	1665.0	1670.5	1701.9	1662.6	1670.9	1676
0:53:00	1689.1	1666.0	1673.8	1704.2	1664.8	1674.3	1679
0:54:00	1692.7	1669.6	1678.3	1708.9	1669.5	1678.6	1684
0:55:00	1697.4	1681.5	1683.7	1712.5	1675.2	1682.1	1689
0:56:00	1701.0	1689.6	1689.1	1717.0	1679.5	1686.7	1694
0:57:00	1705.3	1695.9	1691.2	1719.3	1683.3	1689.1	1697
0:58:00	1708.5	1699.3	1695.6	1722.7	1686.6	1692.3	1701
0:59:00	1711.9	1703.7	1699.9	1726.2	1688.9	1695.7	1705
1:00:00	1716.4	1708.0	1703.1	1730.7	1693.6	1699.3	1709

FILE R39364

APPENDIX B

R-STUD LLC
 2-HR LOAD BEARING WALL ASSEMBLY
 4788356132/R39364
 Test Date: 2018-05-04

FURNACE PRESSURES, INCHES OF WATER

hr:min:sec	Furnace Pressure (Top)	Furnace Pressure (Center)	Furnace Pressure (Bottom)
Format			
0:00:00	-0.242	-0.246	-0.247
0:01:00	-0.077	-0.115	-0.141
0:02:00	0.024	-0.016	-0.039
0:03:00	-0.081	-0.116	-0.140
0:04:00	-0.055	-0.089	-0.118
0:05:00	-0.040	-0.075	-0.106
0:06:00	-0.031	-0.063	-0.095
0:07:00	-0.044	-0.076	-0.111
0:08:00	-0.018	-0.052	-0.086
0:09:00	-0.045	-0.075	-0.113
0:10:00	-0.017	-0.052	-0.083
0:11:00	-0.023	-0.056	-0.094
0:12:00	-0.045	-0.080	-0.115
0:13:00	-0.037	-0.070	-0.108
0:14:00	-0.041	-0.074	-0.114
0:15:00	-0.050	-0.081	-0.120
0:16:00	-0.044	-0.077	-0.114
0:17:00	-0.054	-0.089	-0.124
0:18:00	-0.055	-0.088	-0.124
0:19:00	-0.042	-0.079	-0.114
0:20:00	-0.045	-0.077	-0.117
0:21:00	-0.044	-0.080	-0.117
0:22:00	-0.045	-0.081	-0.118
0:23:00	-0.031	-0.066	-0.104
0:24:00	-0.055	-0.091	-0.127
0:25:00	-0.031	-0.061	-0.102
0:26:00	-0.031	-0.067	-0.102
0:27:00	-0.050	-0.087	-0.119
0:28:00	-0.030	-0.067	-0.104
0:29:00	-0.036	-0.071	-0.105
0:30:00	-0.044	-0.078	-0.117
0:31:00	-0.052	-0.086	-0.125
0:32:00	-0.061	-0.095	-0.130
0:33:00	-0.062	-0.096	-0.133

::5/7/2018

\\4788356132 - Processed Data (HS Duplicate)

Page 1

FILE R39364

APPENDIX B

R-STUD LLC
2-HR LOAD BEARING WALL ASSEMBLY
4788356132/R39364
Test Date: 2018-05-04

FURNACE PRESSURES, INCHES OF WATER

hr:min:sec	Furnace Pressure (Top)	Furnace Pressure (Center)	Furnace Pressure (Bottom)
0:34:00	-0.051	-0.085	-0.123
0:35:00	-0.031	-0.067	-0.103
0:36:00	-0.031	-0.065	-0.103
0:37:00	-0.034	-0.068	-0.106
0:38:00	-0.020	-0.053	-0.094
0:39:00	-0.029	-0.064	-0.101
0:40:00	-0.030	-0.064	-0.103
0:41:00	-0.017	-0.052	-0.089
0:42:00	-0.021	-0.056	-0.093
0:43:00	-0.020	-0.053	-0.092
0:44:00	-0.016	-0.050	-0.089
0:45:00	-0.019	-0.055	-0.093
0:46:00	-0.013	-0.047	-0.086
0:47:00	-0.016	-0.050	-0.090
0:48:00	-0.017	-0.052	-0.089
0:49:00	-0.020	-0.055	-0.092
0:50:00	-0.024	-0.060	-0.095
0:51:00	-0.009	-0.045	-0.080
0:52:00	0.001	-0.036	-0.073
0:53:00	-0.015	-0.054	-0.088
0:54:00	-0.006	-0.041	-0.077
0:55:00	-0.009	-0.043	-0.079
0:56:00	-0.015	-0.050	-0.090
0:57:00	-0.021	-0.057	-0.094
0:58:00	-0.022	-0.058	-0.095
0:59:00	-0.016	-0.052	-0.089
1:00:00	0.000	-0.037	-0.072

::5/7/2018

\\4788356132 - Processed Data (HS Duplicate)

Page 2

FILE R39364

APPENDIX C

R-STUD LLC
 2-HR LOAD BEARING WALL ASSEMBLY
 4788356132/R39364
 Test Date: 2018-05-04

DEFLECTION, INCHES

Time hr:min:sec	Sill Deflection 1	Sill Deflection 2
0:00:00	0.00	0.00
0:01:00	0.00	0.00
0:02:00	0.00	0.00
0:03:00	-0.01	0.00
0:04:00	-0.01	0.00
0:05:00	-0.01	0.00
0:06:00	-0.01	0.00
0:07:00	-0.02	-0.01
0:08:00	-0.02	-0.01
0:09:00	-0.02	-0.01
0:10:00	-0.03	-0.02
0:11:00	-0.03	-0.01
0:12:00	-0.03	-0.02
0:13:00	-0.03	-0.02
0:14:00	-0.04	-0.02
0:15:00	-0.04	-0.02
0:16:00	-0.04	-0.03
0:17:00	-0.05	-0.03
0:18:00	-0.05	-0.03
0:19:00	-0.05	-0.03
0:20:00	-0.05	-0.03
0:21:00	-0.05	-0.03
0:22:00	-0.05	-0.03
0:23:00	-0.05	-0.04
0:24:00	-0.05	-0.04
0:25:00	-0.05	-0.04
0:26:00	-0.05	-0.04
0:27:00	-0.06	-0.04
0:28:00	-0.06	-0.04
0:29:00	-0.06	-0.04
0:30:00	-0.06	-0.04
0:31:00	-0.06	-0.04
0:32:00	-0.06	-0.04
0:33:00	-0.06	-0.04
0:34:00	-0.06	-0.04

FILE R39364

APPENDIX C

R-STUD LLC
2-HR LOAD BEARING WALL ASSEMBLY
4788356132/R39364
Test Date: 2018-05-04

DEFLECTION, INCHES

Time	Sill Deflection	Sill Deflection
hr:min:sec	1	2
0:35:00	-0.07	-0.05
0:36:00	-0.07	-0.05
0:37:00	-0.07	-0.05
0:38:00	-0.07	-0.05
0:39:00	-0.07	-0.05
0:40:00	-0.07	-0.05
0:41:00	-0.07	-0.05
0:42:00	-0.08	-0.05
0:43:00	-0.08	-0.06
0:44:00	-0.08	-0.06
0:45:00	-0.08	-0.06
0:46:00	-0.08	-0.06
0:47:00	-0.08	-0.06
0:48:00	-0.09	-0.07
0:49:00	-0.09	-0.07
0:50:00	-0.09	-0.07
0:51:00	-0.10	-0.07
0:52:00	-0.10	-0.08
0:53:00	-0.11	-0.09
0:54:00	-0.12	-0.10
0:55:00	-0.13	-0.10
0:56:00	-0.14	-0.11
0:57:00	-0.15	-0.12
0:58:00	-0.16	-0.13
0:59:00	-0.17	-0.14
1:00:00	-5.61	-5.56